

# New diffractive measurements in H1 using the VFPS

Tomáš Hreus

*Université Libre de Bruxelles*



On behalf of the H1 Collaboration

*LOW X MEETING,  
23-27 June 2010, Kavala, Greece*

# Diffraction at HERA

At HERA, 10% of low-x DIS events are diffractive

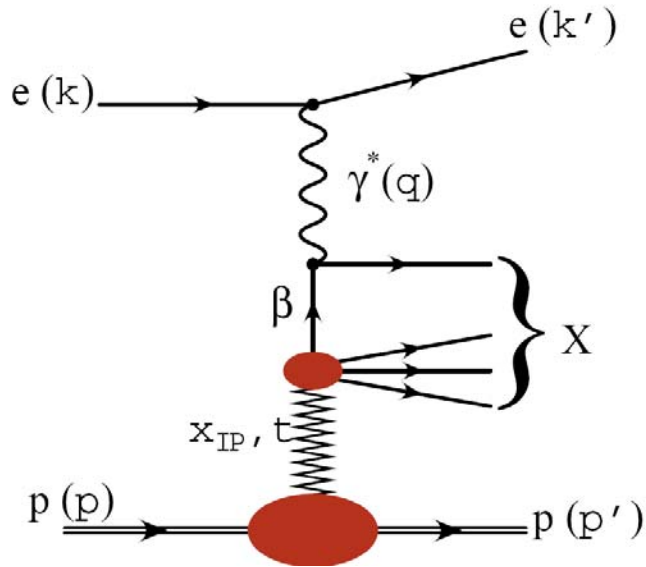

## additional kinematics defined wrt DIS:

$$x_{IP} = q \cdot (p - p') / q \cdot p$$

momentum fraction of colour singlet exchange

$$\beta = -q^2 / q \cdot (p - p')$$

momentum fraction of struck quark

$$t = (p - p')^2$$

4-momentum transfer squared

Probe QCD structure of colour singlet

**HERA1:** several measurements of F2D exploiting different methods to select diffractive events: proton tagging, large-rapidity-gaps

**HERA2:** to benefit from luminosity upgrade, **new Very Forward Proton Spectrometer** with high acceptance and low background

# A Very Forward Proton Spectrometer in H1

- VFPS location is optimised for acceptance: 220m from IP, using bending of HERA beam
- proton beam is approached horizontally

- VFPS in cold section: bypass needed to re-route the cold beam line segments
  - 10m drift section replaced by a new warm beam pipe

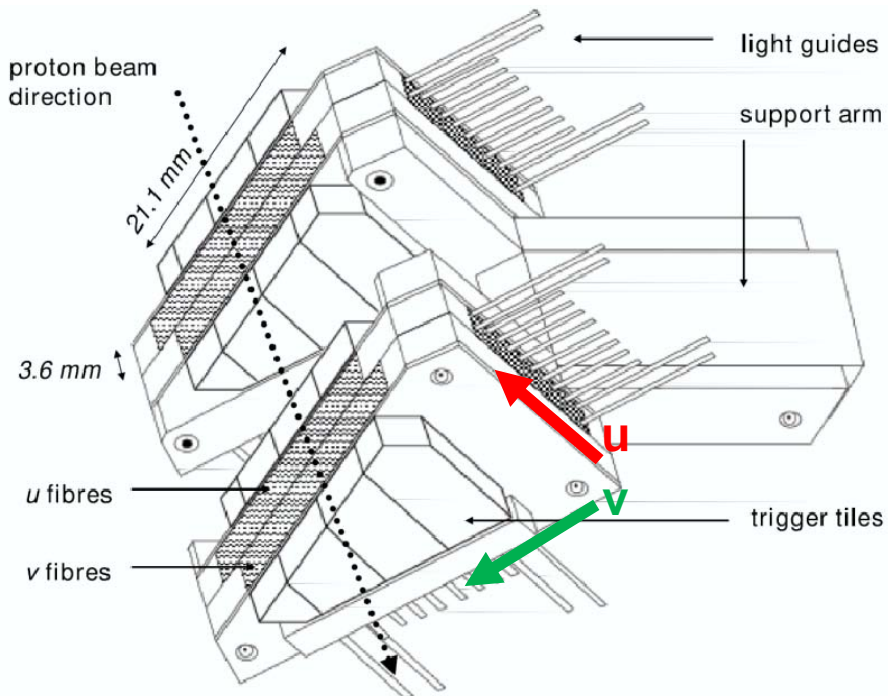

## Detectors:

- 2 retractable “Roman Pot” stations (218m, 222m) equipped with 2 scintillating fibre detectors each
- 1 fibre detector measures both **u** and **v** track coordinates
- 4 Trigger Tiles / plane, 4 planes per RP (deliver a Level1 trigger signal)

# VFPS: Acceptance

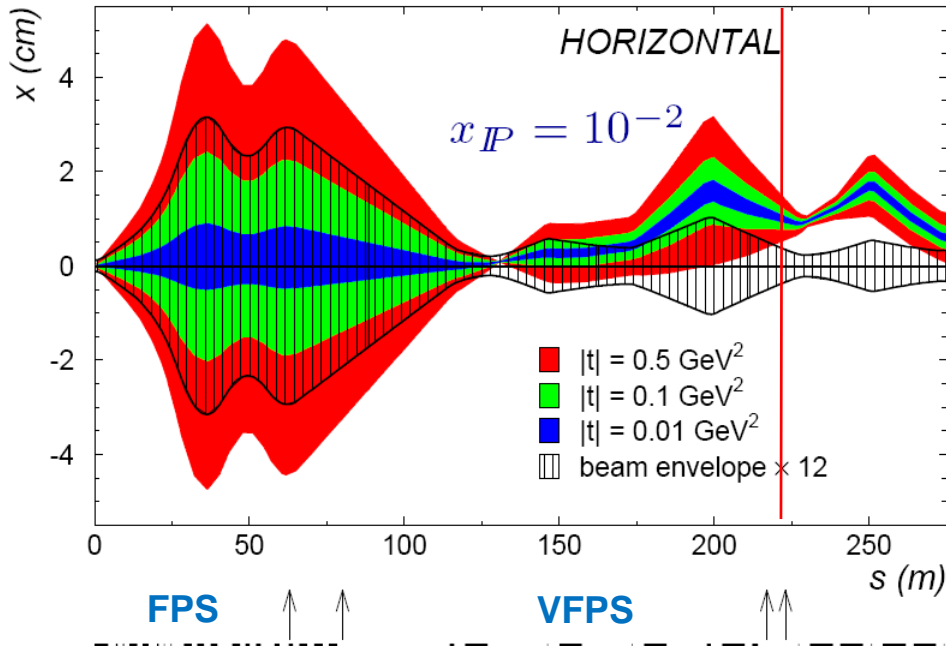

- acceptance is highest between

$0.006 < x_{IP} < 0.025$  and  $|t| < 0.25 \text{ GeV}^2$   
(down to lowest  $|t|$ )

and depends on **VFPS position** during run (affects low  $x_{IP}$ )

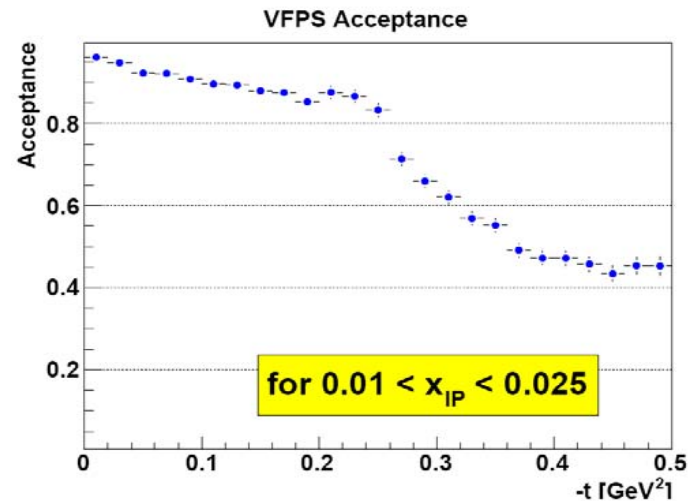
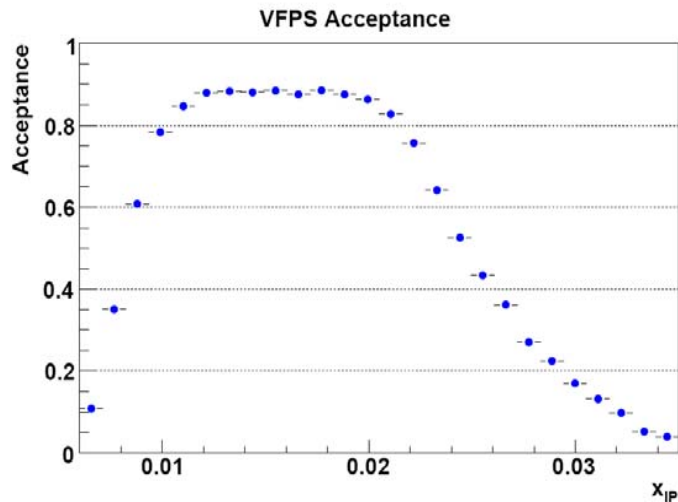

# VFPS Detector: Calibration

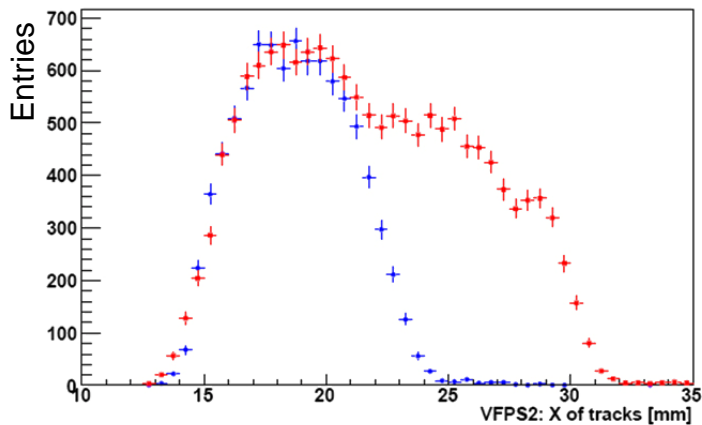
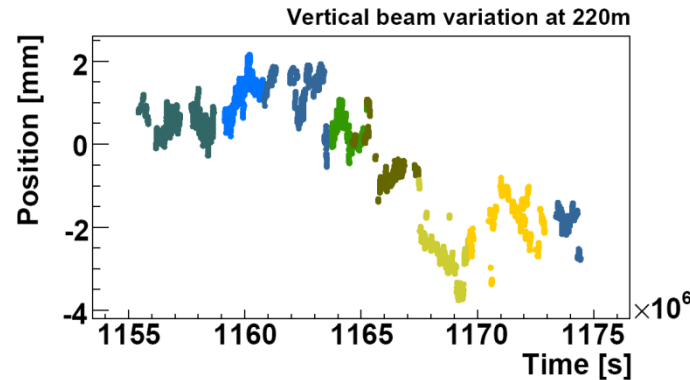
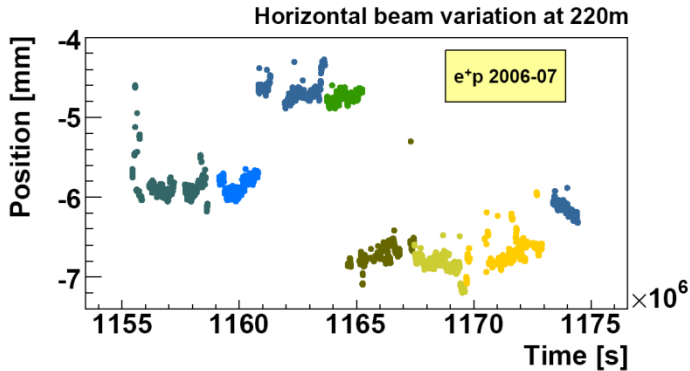

(bump: ● 1mm ● 6mm)

To increase acceptance, a HERA-operated local beam bumps were applied during 2006/07

- beam position is measured by monitors (by current induction) and corrected on event-by-event basis
- $x_{IP}$  is reconstructed assuming linear (and  $t=0$ ) approximation

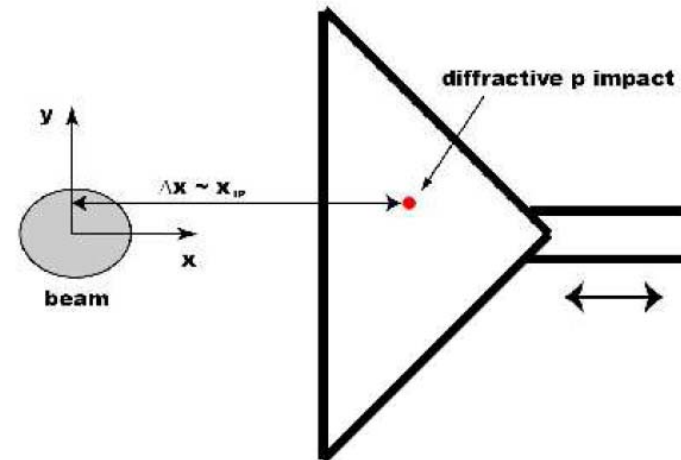

$$x_{IP} = A * VFPS\_track\_x + B$$

- distance in x-coor between the beam center and VFPS impact gives the  $x_{IP}$  value (more complete calibration allowing reconstr. of  $p_x$  and  $p_y$  to follow)

# Calibration & Track Efficiency: $\rho$ x-check

- cross-check of the calibration with  $\rho$  events

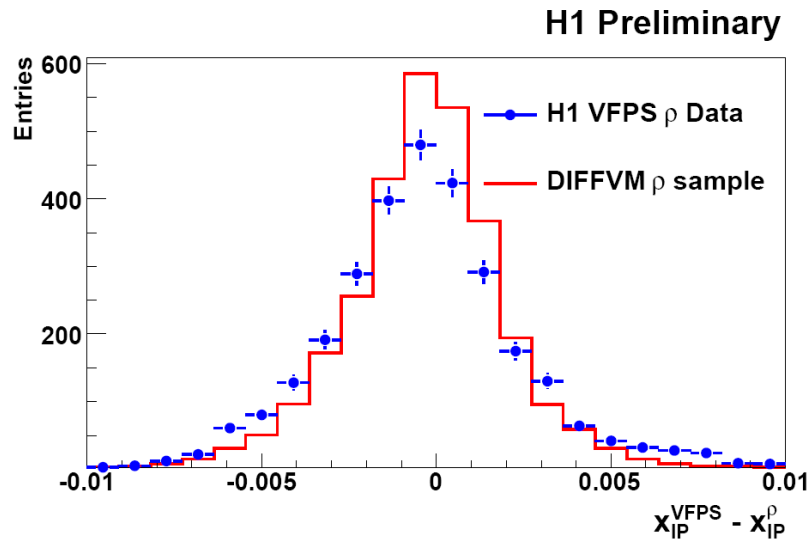

$$e+p \rightarrow e + \rho + p$$



$$\pi^+\pi^-$$

- comparing  $x_{IP}^{\rho}$  reconstructed from  $\rho$  decay tracks to  $x_{IP}^{VFPS}$  reconstructed using VFPS

- check independent of MC, shows that  $x_{IP}$  is correctly reconstructed from VFPS

**absolute calibration 5%  
resolution 12%**

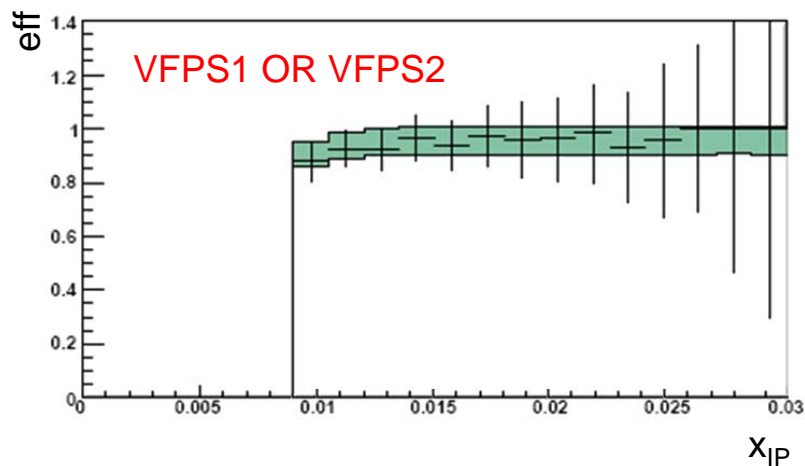

- simulation of VFPS track reconstruction efficiencies cross-checked using  $\rho$  in DIS data sample

**track efficiency 96% +/- 4%**

# Motivation & Event Selection

$$\frac{d^3\sigma_{ep\rightarrow eXp}}{dQ^2 d\beta dx_{IP}} = \frac{4\pi\alpha^2}{\beta Q^4} \cdot \left(1 - y + \frac{y^2}{2}\right) \cdot \sigma_r^{D(3)}(Q^2, \beta, x_{IP})$$

- free of proton dissociation
- high acceptance in  $0.006 < x_{IP} < 0.025$  and  $|t| < 0.25 \text{ GeV}^2$ 
  - low normalisation uncertainty (5%)
- improved resolution in  $x_{IP}$  and  $\beta$  (both reconstructed from VFPS)

Using H1 data collected in 2006 and 2007 ( $e^+p$  reactions,  $s^{1/2} = 319 \text{ GeV}$ ), integrated luminosity when VFPS was in operation (close to beam): **87.4 pb<sup>-1</sup>**

## Kinematic reconstruction:

$$y = y_{el}^2 + y_{da}(1 - y_{da})$$

$$Q^2 = 4E^2(1 - y)/\tan^2(\theta_{e'}/2)$$

$$x_{IP} = A \cdot \text{VFPS-track-X} + B$$

$$\beta = x/x_{IP}$$

## Basic event selection:

scattered electron energy	> 10 GeV
reconstructed vertex	needed
VFPS trigger	either of VFPS stations
VFPS tracks	either of VFPS stations
y (inelasticity)	> 0.02

## Kinematic range:

$$\begin{aligned} 4.5 &< Q^2 < 100 \text{ GeV}^2 \\ 0.008 &< \beta < 1 \\ 0.009 &< x_{IP} < 0.026 \end{aligned}$$

# Beamgas+DIS Background Estimate

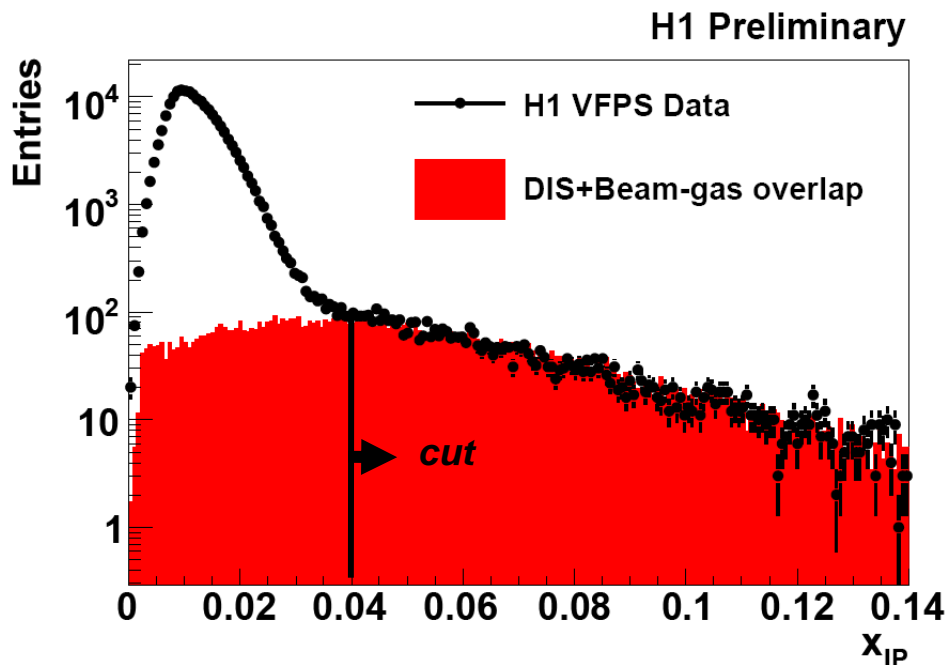

- Want to estimate the contamination from the beam-gas events in VFPS with an overlap of the DIS event in the main H1.

$$\begin{cases} ep \rightarrow eX \\ pA \rightarrow p(A') \end{cases}$$

- background estimated from data (using independent trigger) to be **2%** for  $x_{IP}$  (main H1)  $< 0.04$  (analysis cut)

- **low background:** proton beam bending suppresses the beam-gas protons accumulated in the straight section around interaction point



# Comparison with Simulation

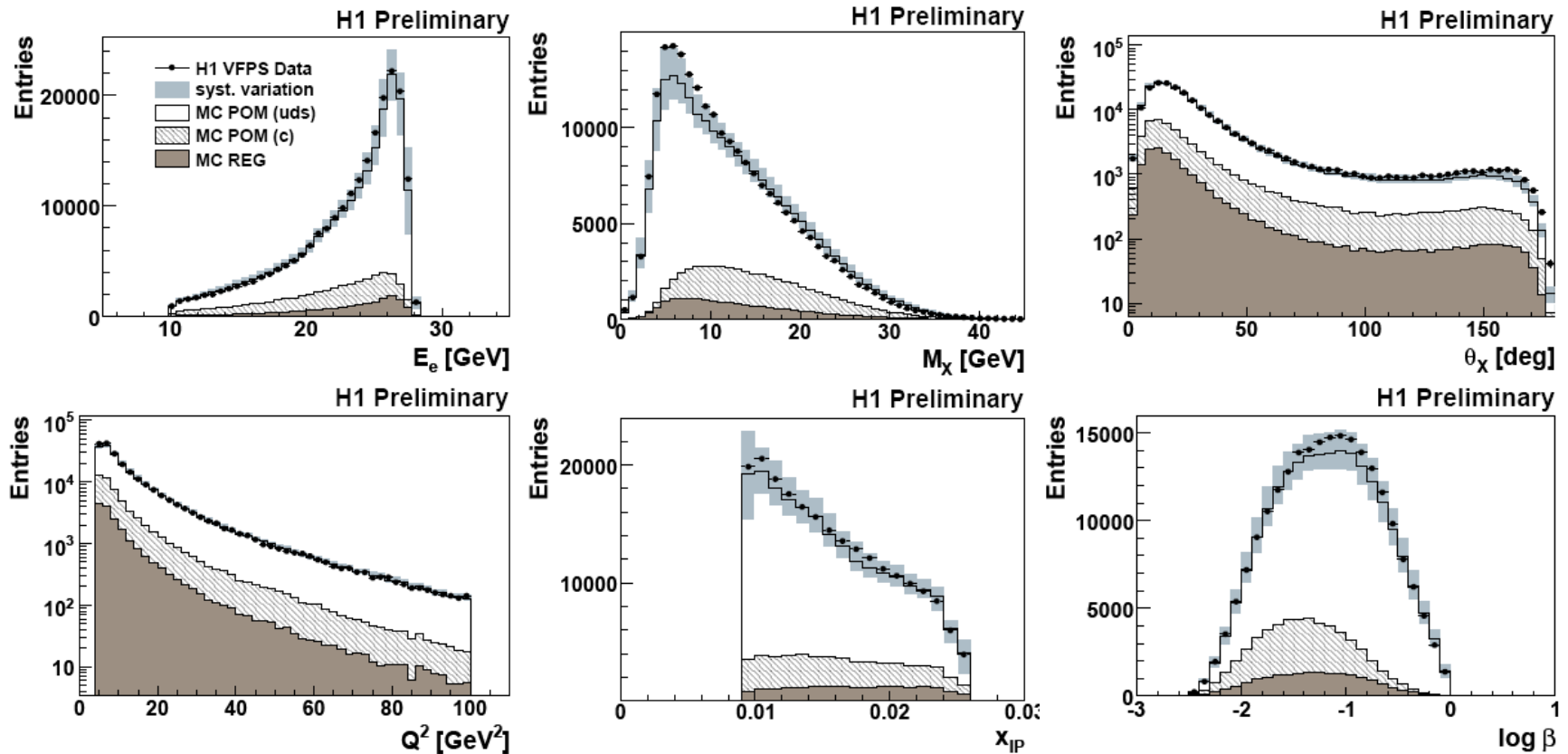

- MC: RAPGAP31 with th. prediction based on H1 2006 DPDF Fit B (scaled to  $M_p$ )
- good agreement between Data and MC within total systematics
- total systematics max 8% - 14% (depending on the bin)

# Reduced Cross Section

H1 PRELIMINARY

● H1 VFPS Preliminary  
□ H1 FPS Preliminary  
○ H1 LRG Preliminary x 0.81  
○ H1 LRG Published x 0.81  
 — H1 2006 DPDF Fit B x 0.81  
 - - - H1 2006 DPDF Fit B x 0.81 (extrapol.)

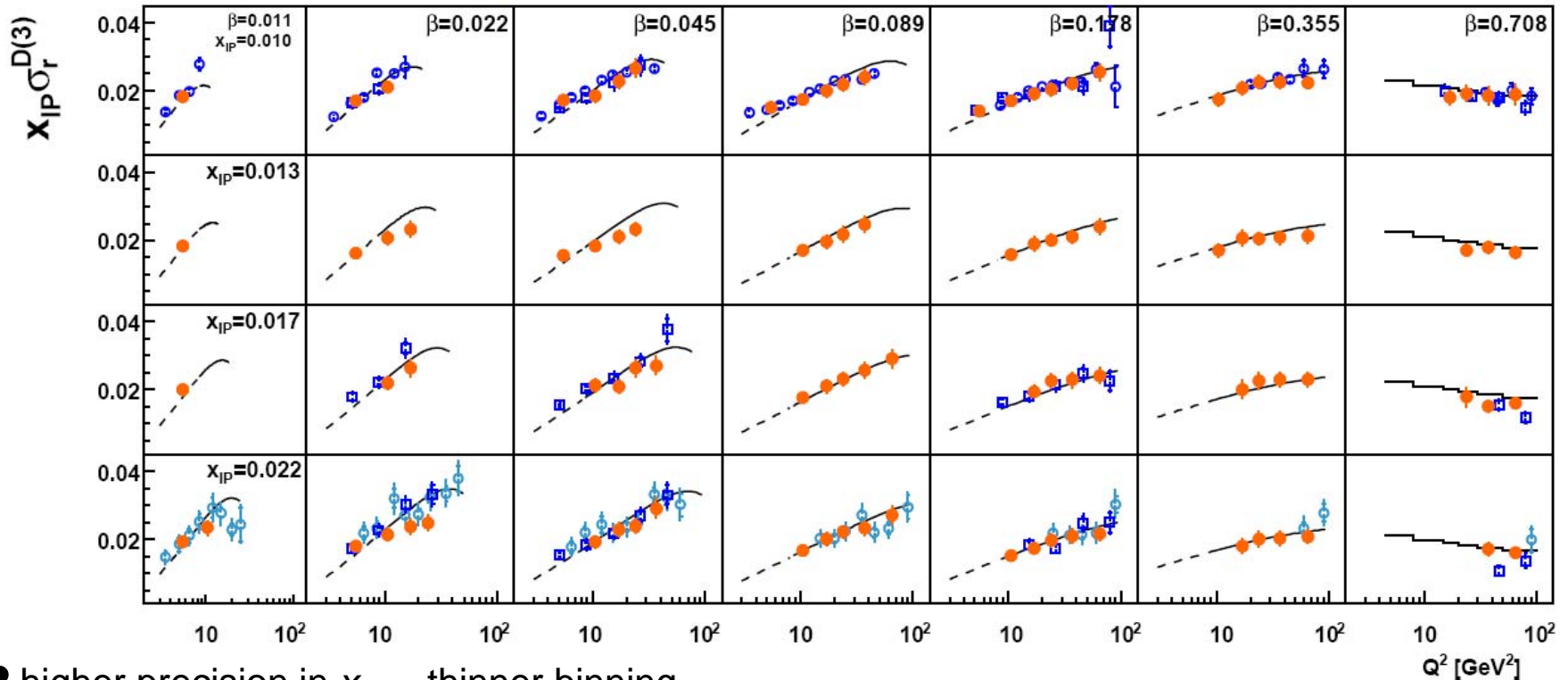

- higher precision in  $x_{IP}$  – thinner binning
- improved normalisation uncertainty (5%)
- scaling violations
- very good agreement with H1 2006 Fit B, scaled to proton mass (from  $M_Y < 1.6$  GeV)
  - highest  $\beta$  bin: comparison to bin-averaged values

# Reduced Cross Section

**H1 PRELIMINARY**

- H1 VFPS Preliminary
- H1 FPS Preliminary
- H1 LRG Preliminary x 0.81
- H1 LRG Published x 0.81
- H1 2006 DPDF Fit B x 0.81
- - - H1 2006 DPDF Fit B x 0.81 (extrapol.)

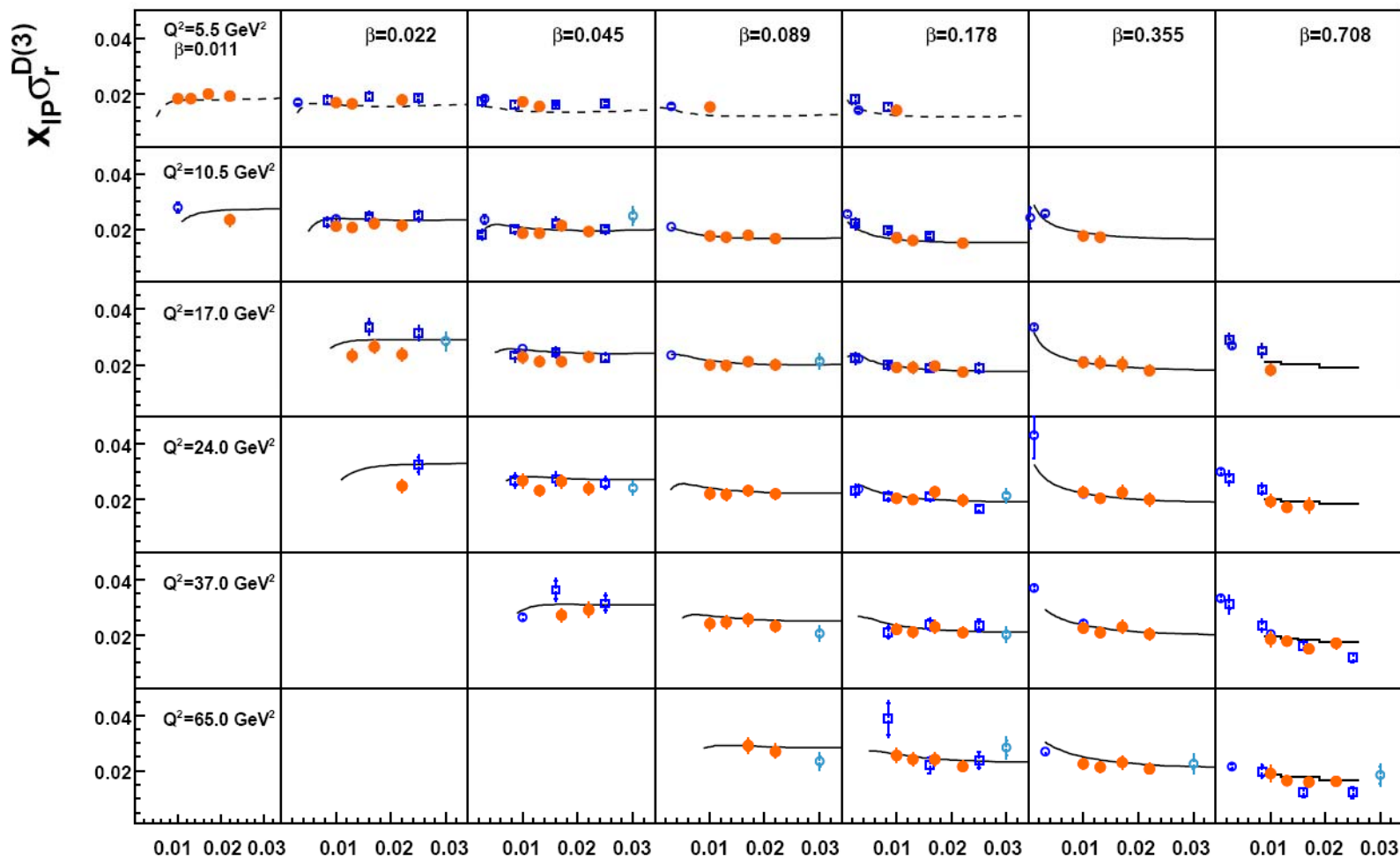

# Reduced Cross Section

**H1 PRELIMINARY**

- H1 VFPS Preliminary  
□ H1 FPS Preliminary  
○ H1 LRG Preliminary x 0.81
- H1 LRG Published x 0.81  
 H1 2006 DPDF Fit B x 0.81  
 H1 2006 DPDF Fit B x 0.81 (extrapol.)

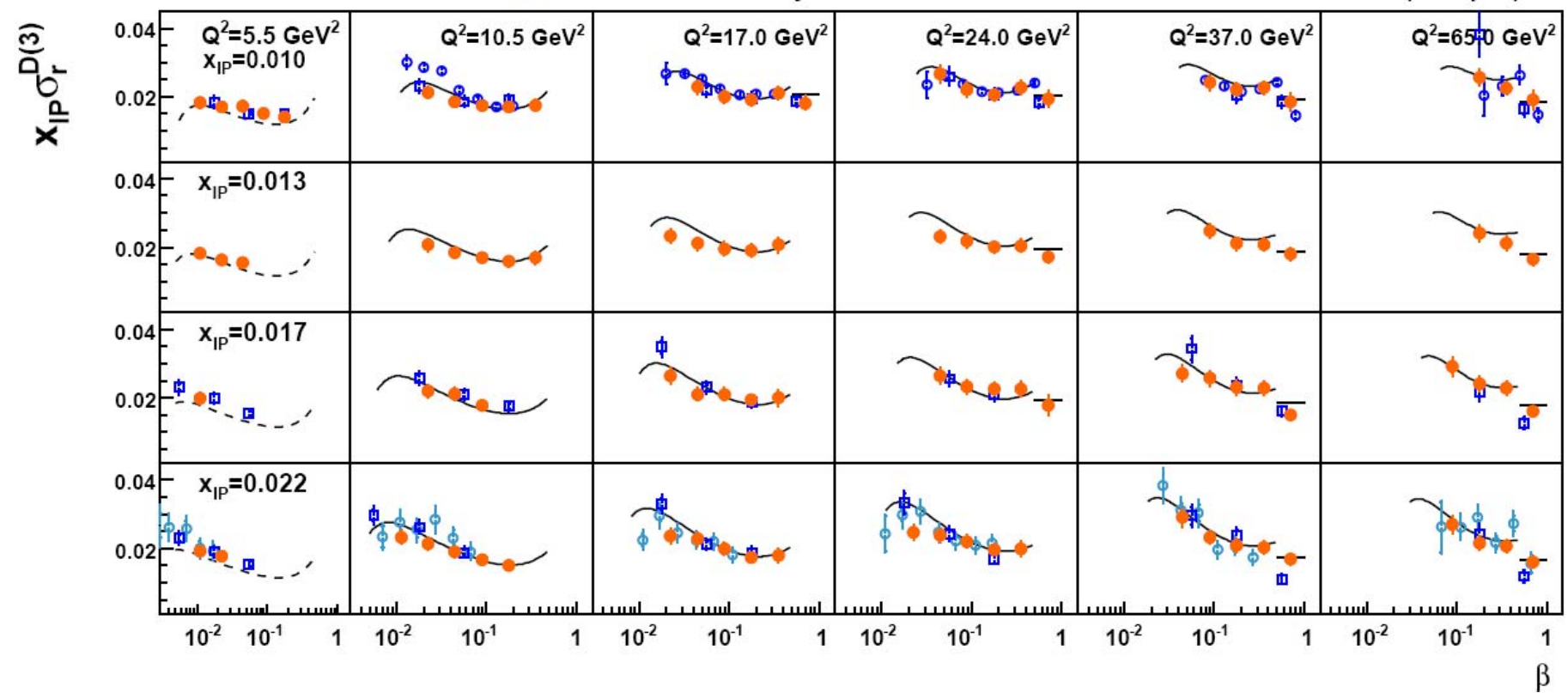

- the highest  $\beta$  bin: data compared to bin-averaged values of H1 2006 Fit B

# Ratio VFPS / FPS ( $x_{IP}$ )

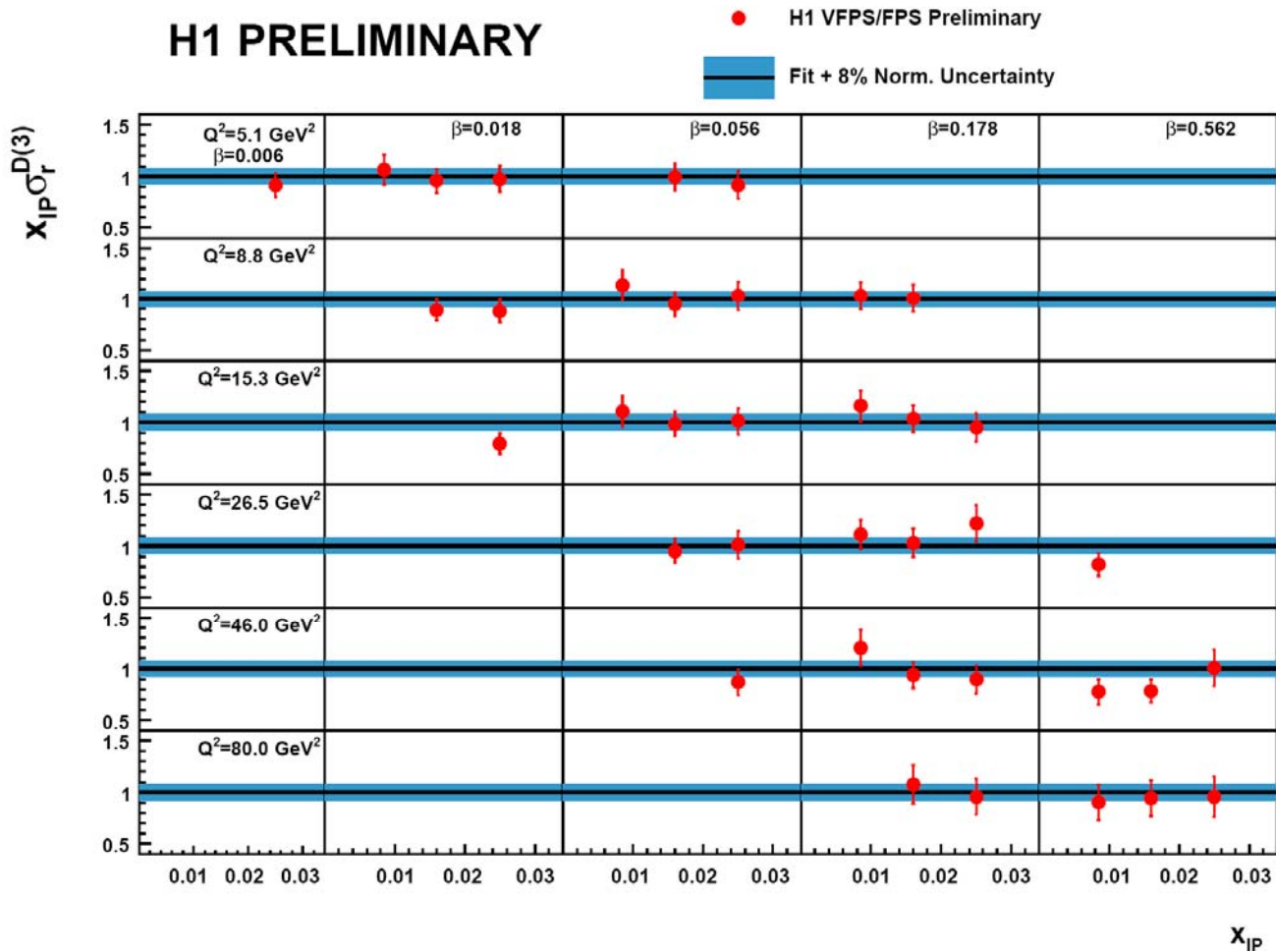

- best is to compare measurements with tagged proton
- no proton dissociation uncertainty
- many systematics cancel
- VFPS analysis redone in FPS binning

**ratio VFPS / FPS = 0.96 +/- 0.02 (stat) +/- 0.11 (syst) +/- 0.08 (norm)**

- all points stable

# Reduced Cross Section Comparison

**H1 PRELIMINARY**

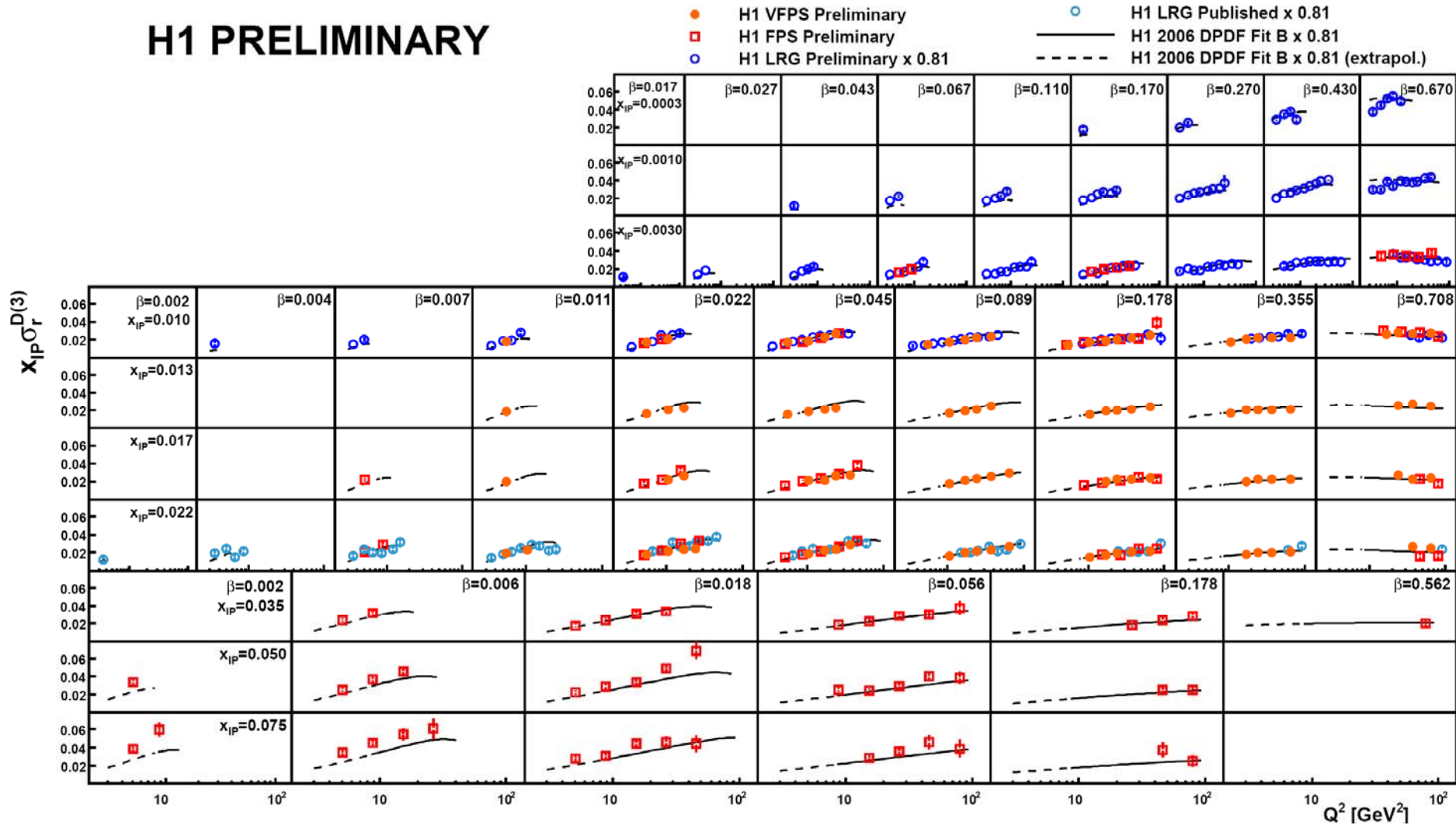

# Conclusions

- first measurement done with VFPS detector, based on 2006/07e+ data
  - VFPS took data during 2005-2007
  - improvement of  $x_{IP}$  and  $\beta$  resolutions with respect to other methods
  - VFPS normalisation uncertainty 5%
  - very low background contamination (2%)
  - diffractive reduced cross-section measured, in agreement with
    - H1 2006 DPDF Fit B
    - H1 LRG measurements
    - H1 FPS measurement