

The Search for New Physics at HERA

Gerhard Brandt (DESY)
On behalf of the H1 and ZEUS Collaborations



July 22-28, 2010



HERA Collider and Experiments



HERA

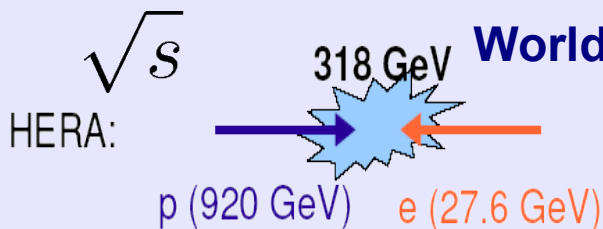

World's only ep Collider at DESY, Hamburg
Active 1991-2007

H1 and ZEUS Experiments

Asymmetric Design

4 π Coverage

Excellent Lepton ID + HFS Reconstruction

HERA-I (1994-00)

~130 pb⁻¹ per exp., (90% e⁺p)

HERA-II (2003-07)

Luminosity upgrade

Long. e polarisation (avg. 40%)

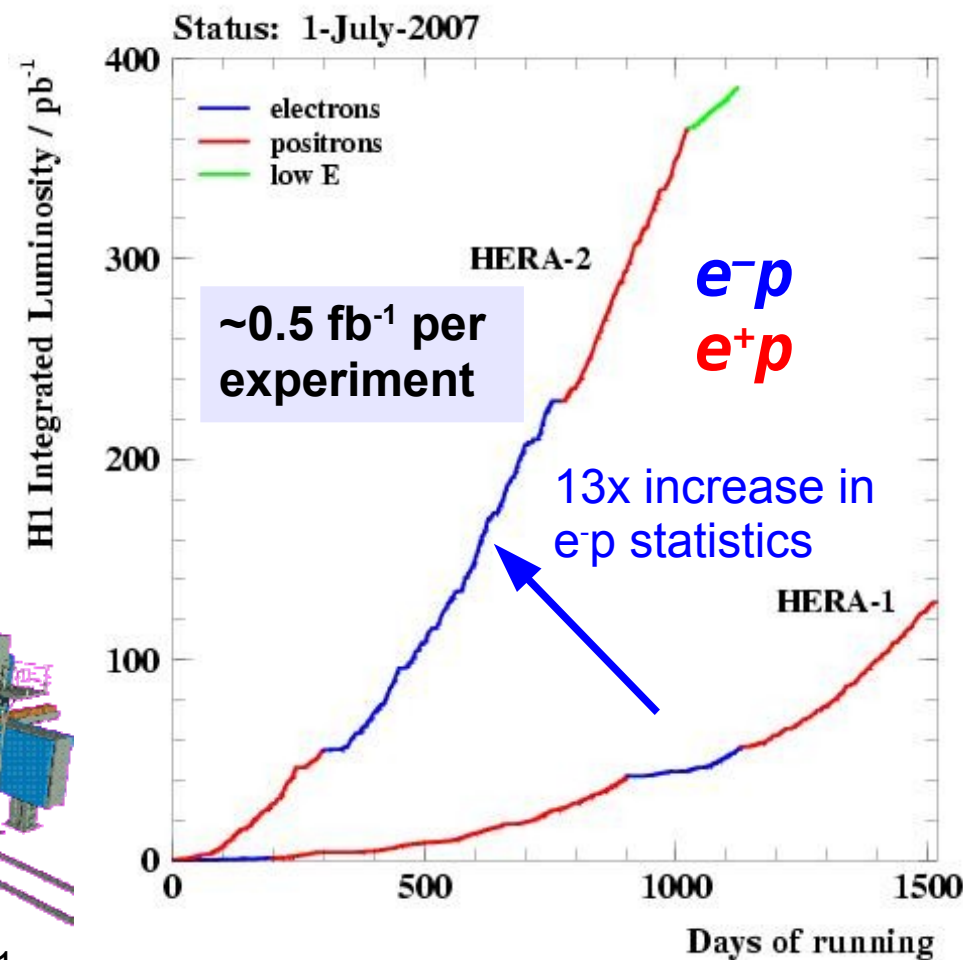



A General Search for New Phenomena at HERA

H1 Collaboration, DESY-08-173, Phys.Lett.B674:257-268,2009

Search for contact interactions in ep collisions with the ZEUS experiment at HERA

ZEUS Collaboration, ZEUS-prel-09-013

Search for Excited Quarks in ep Collisions at HERA

H1 Collaboration, DESY-09-040, Phys.Lett.B678:335-343,2009

Search for Single Top Quark Production at HERA

H1 Collaboration, DESY-09-050, Phys.Lett.B678:450-458,2009

Search for Squarks in R-Parity Violating Supersymmetry with the H1 Experiment at HERA

H1 Collaboration, H1prelim-10-063

Search for Lepton Flavour Violation at HERA

H1 Collaboration, H1prelim-10-061

Search for Contact Interactions at HERA

H1 Collaboration, H1prelim-10-062

Searches using ...

- Inclusive Measurement
- Exclusive Final States

Deep-Inelastic Scattering at high Q^2



- Main Standard Model processes in ep collisions

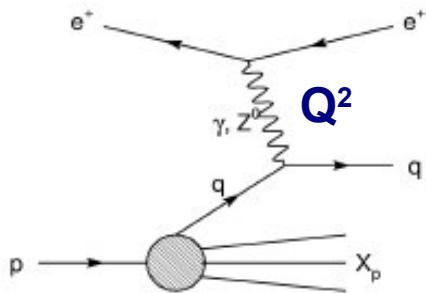

Neutral Current

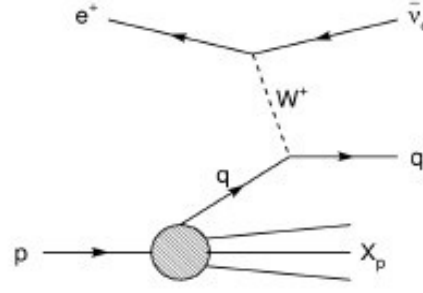

Charged Current

- Sq. Momentum transfer Q^2 up to 40.000 GeV^2
- Spatial resolution $\sim 1/Q^2 = 10^{-18}$ m
- Can probe small distances

- Deviation from SM prediction may indicate new physics
 - can appear like effective contact interaction
- Investigated by
 - ZEUS using events + Likelihood method
 - H1 using χ^2 -fit to cross sections

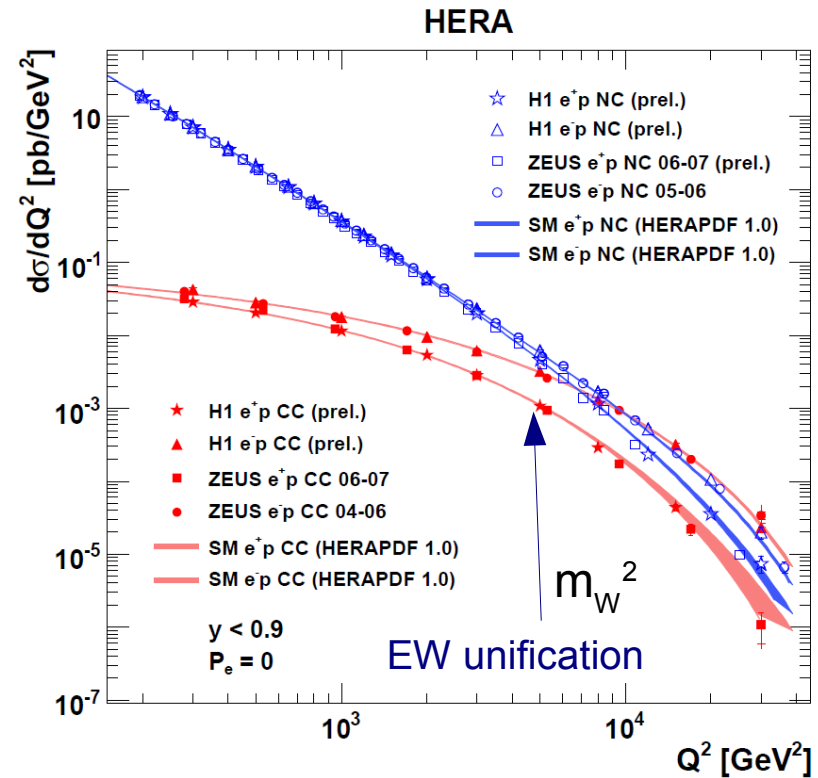
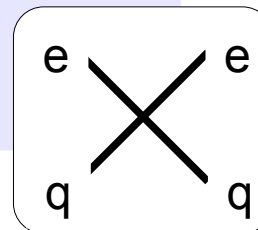

compare H1 to CTEQ6m

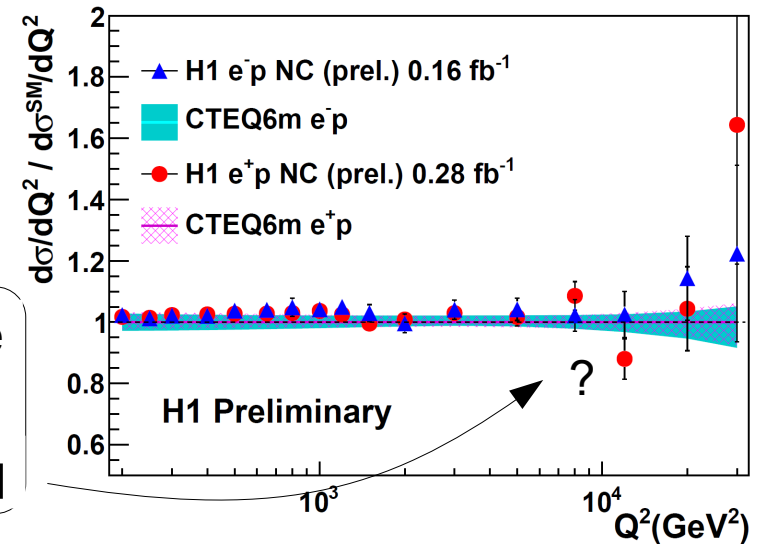

- Consider vector currents as additional term to SM Lagrangian

$$\mathcal{L}_V = \sum_q \sum_{a,b=L,R} \eta_{ab}^q (\bar{e}_a \gamma_\mu e_a) (\bar{q}_b \gamma^\mu q_b)$$

General Compositeness

- Models defined by coefficients $\epsilon_{ab} = \pm 1, 0$

$$\eta_{ab}^q = \epsilon_{ab} \frac{4\pi}{\Lambda^2}$$

- Limits on effective mass scale Λ :
 $\Lambda > 3.7 - 8.9$ [TeV]

Quark Radius

- Formfactor f_q modifies cross section
- Assuming point-like leptons ($f_e=0$)

$$\frac{d\sigma}{dQ^2} = \frac{d\sigma^{SM}}{dQ^2} \left(1 - \frac{1}{6} R_q^2 Q^2\right)$$

- $R_q < 0.63 - 0.65$ [10^{-18} m]

Heavy Leptoquarks

- BRW-framework
- $M_{LQ}/\lambda_{LQ} > 0.63 - 1.94$ [TeV]

$$\eta_{ab}^q = \epsilon_{ab}^q \frac{\lambda^2}{M_{LQ}^2}$$

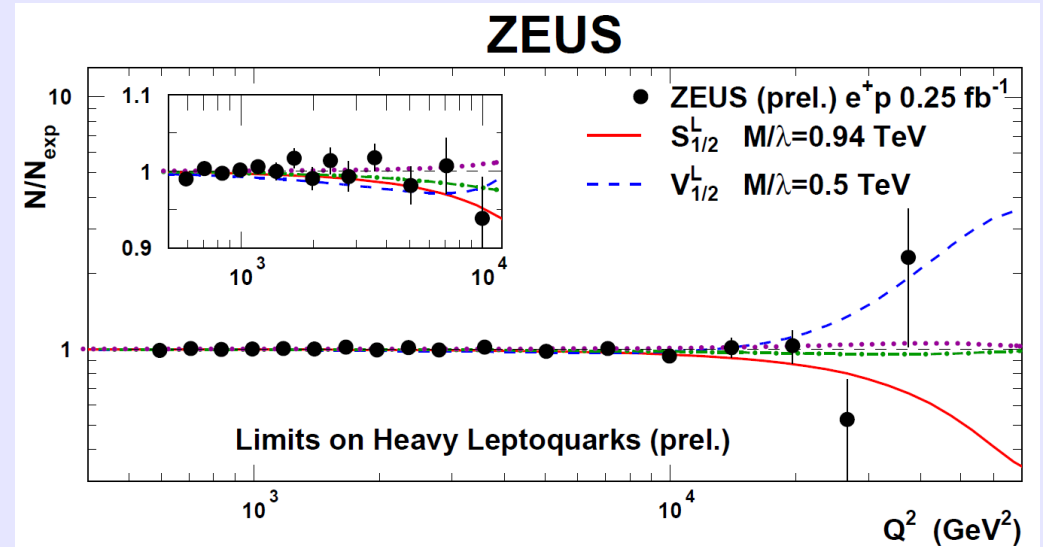

Large Extra Dimensions

- ADD model: $4+n$ dimensions leads to effective CI with scale M_s

$$\eta_G = \frac{\lambda}{M_S^4}$$

- $M_s > 0.90 - 0.94$ [TeV]

General Search

H1 General Search at HERA (e^+p , 285 pb^{-1})

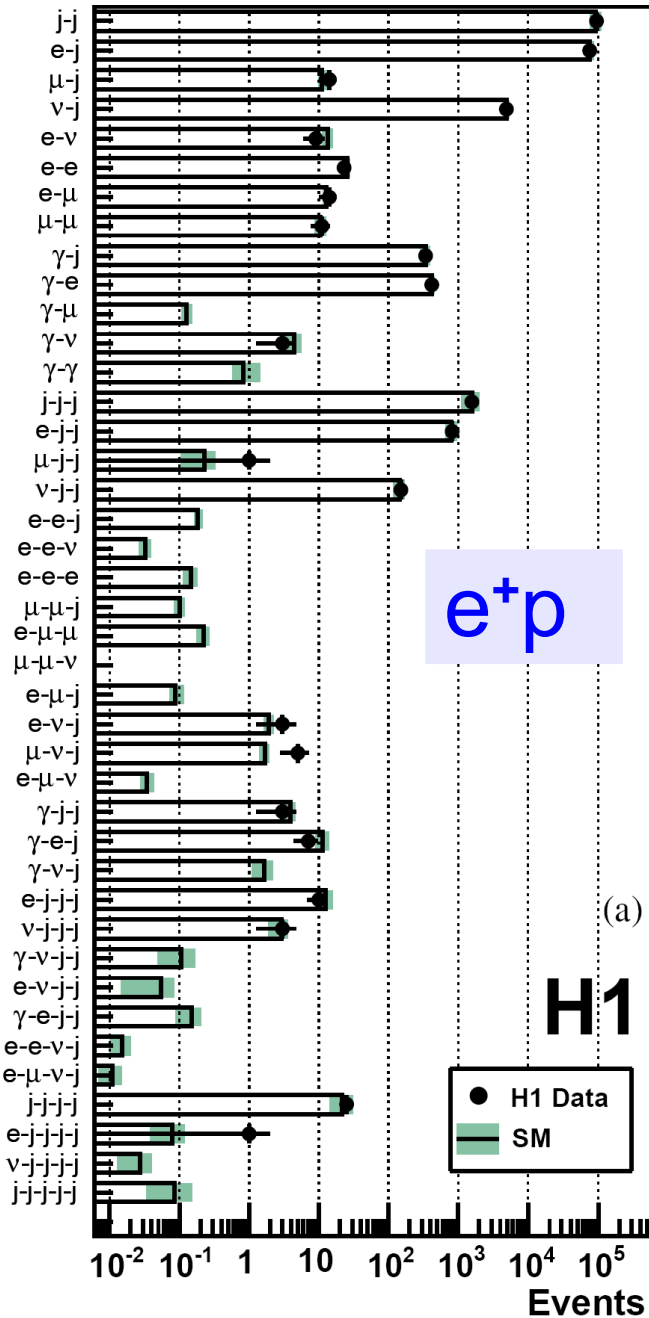

H1 General Search at HERA (e^-p , 178 pb^{-1})

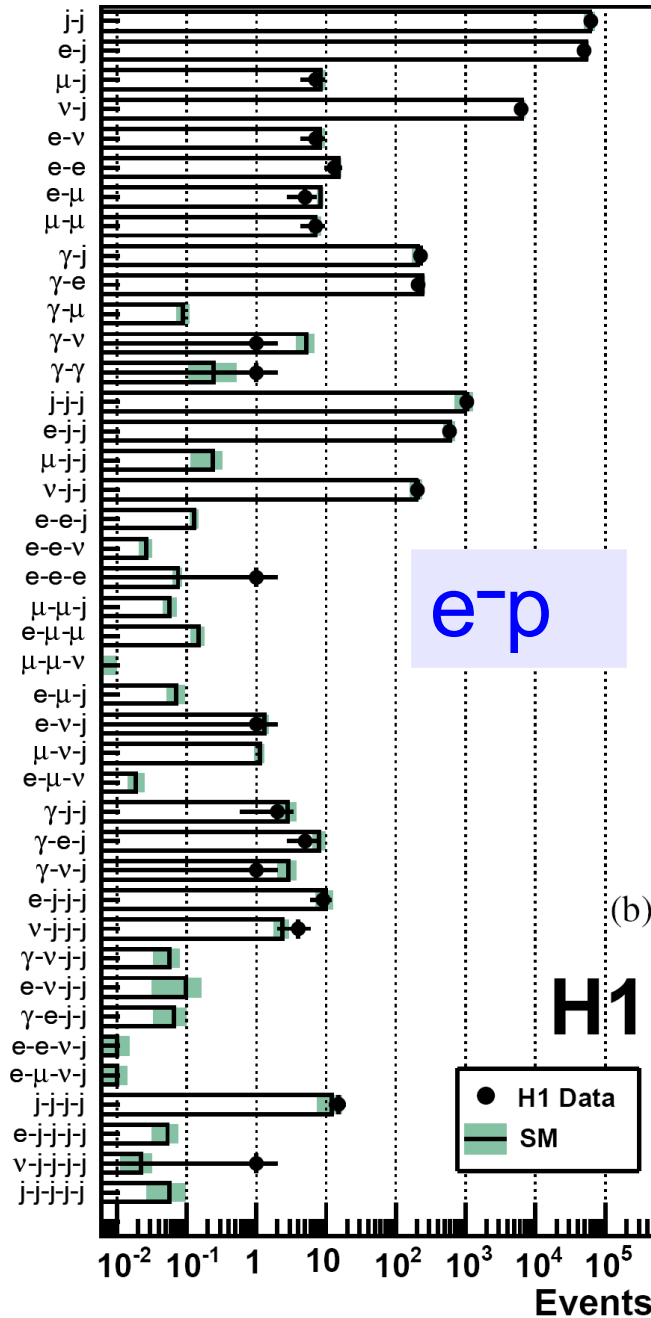

2

N_{bodies}

3

4

5

- Select all combinations of γ , e , μ , jets, ν with $P_T > 20$ GeV

- Stat. algorithm to look for deviations from SM

- Good overall agreement of yields and shapes between data and MC

- Shown are the **41** channels with $N_{\text{obs}} > 0$ or prediction $N_{\text{SM}} > 0.01$

- Many topologies appear also in specific analyses

This talk:

- Lepton Flavor Violation
- Isolated Leptons
- Excited fermions
- Squarks
- *Multi-Leptons*

Search for Lepton Flavor Violation



- Search for Production of Lepton Flavor Violating Leptoquarks in 0.41 fb^{-1}

For scalar LQ $\beta=0.5$ Tevatron limit $M_{LQ} > 259 \text{ GeV}$

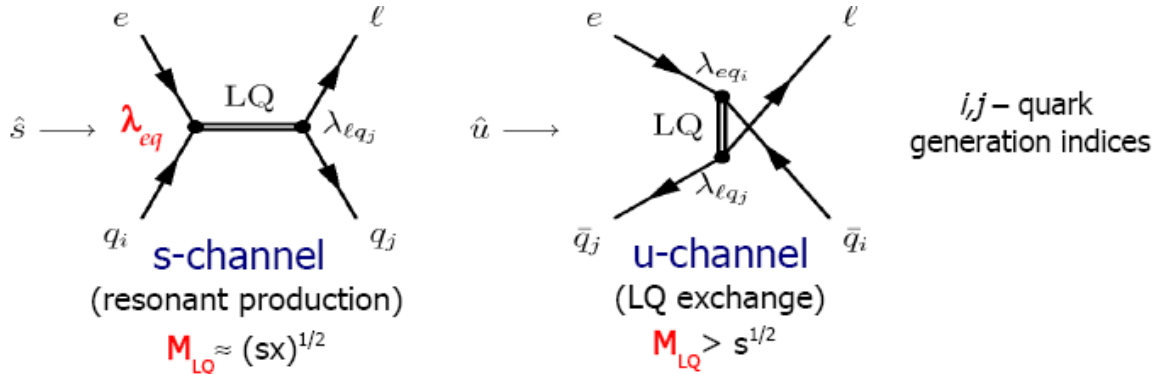

- Final state similar to NC, replacing e with μ, τ
- Limits on couplings set on 14 LQ types of BRW framework assuming non-zero 2nd/ 3rd gen. coupling:

$$\lambda_{\mu q} = \lambda_{e q}, \lambda_{\tau q} = 0$$

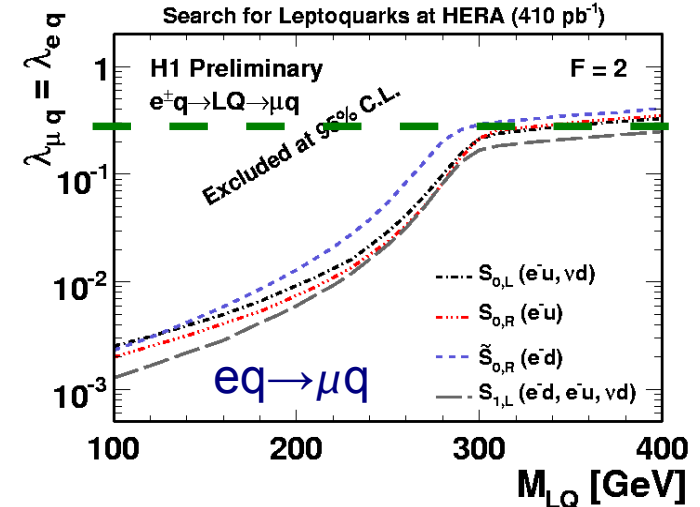

For $\lambda=0.3$ (em. strength)
 $M_{LQ} > 304-530 \text{ GeV}$

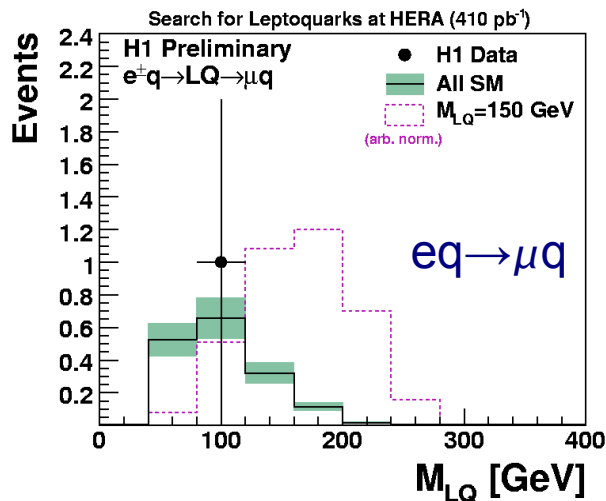

1 obs. / 1.6 ± 0.5 exp.

G. Brandt - Searches at HERA

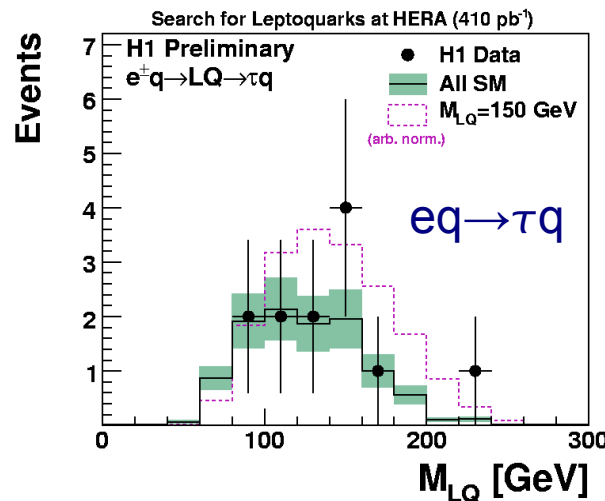

12 obs. / 10.6 exp.

ICHEP '10

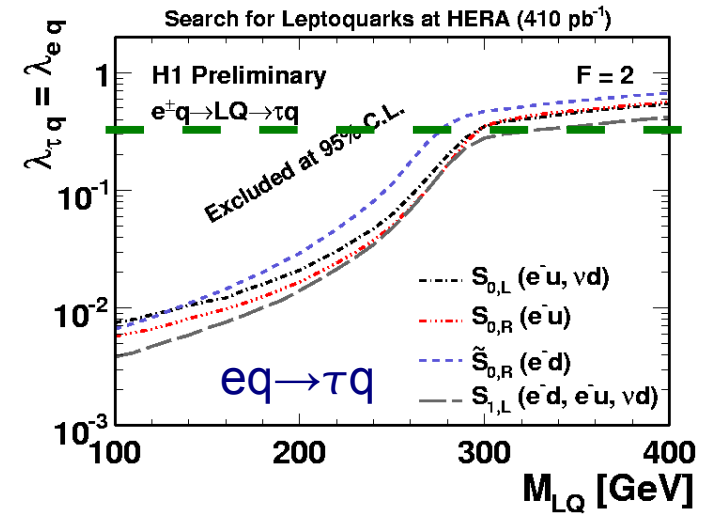

For $\lambda=0.3$ (em. strength)
 $M_{LQ} > 272-450 \text{ GeV}$

Isolated Leptons in Events with Missing P_T



- Select isolated $p_T > 10$ GeV electrons or muons in events with $P_T^{\text{miss}} > 12$ GeV
- Good overall agreement with Standard Model (*W-Production*)
- Interesting **events** at high hadronic $P_T^X > 25$ GeV observed in e^+p by H1

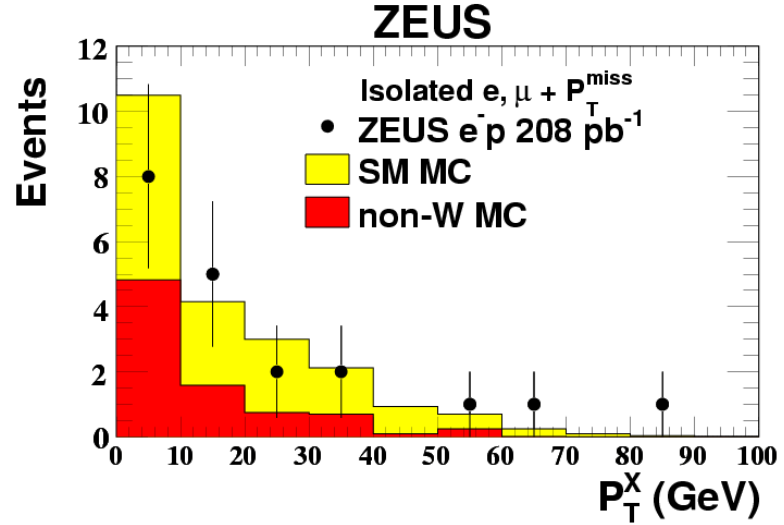
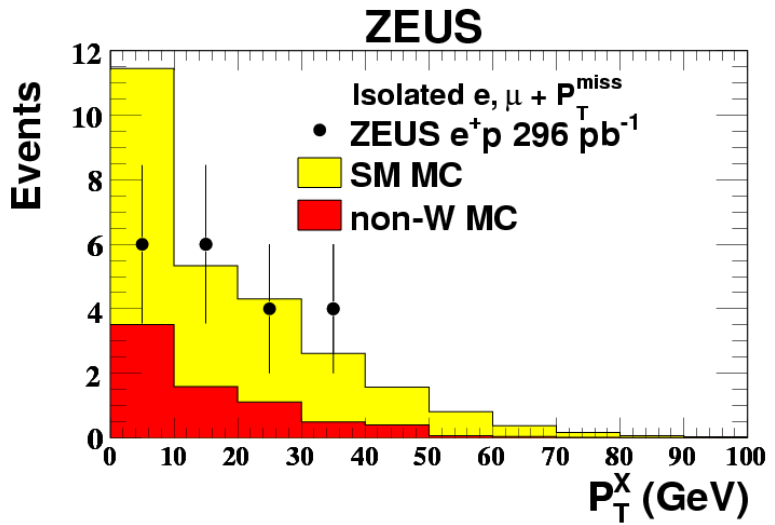
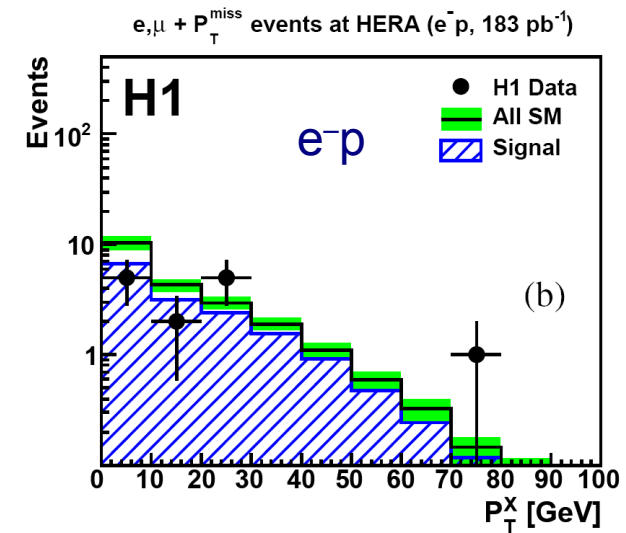
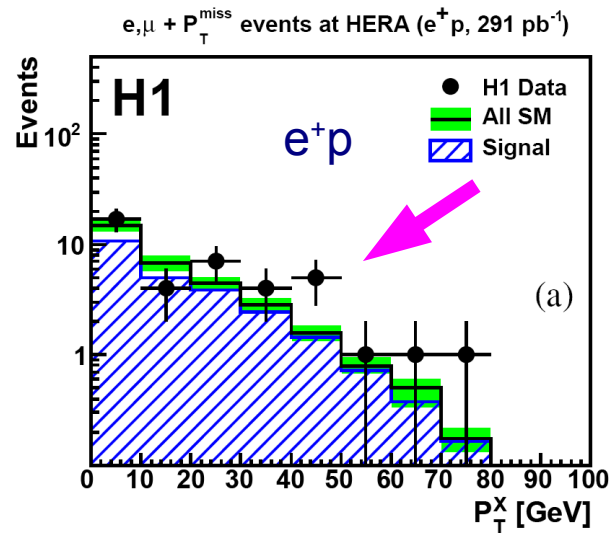
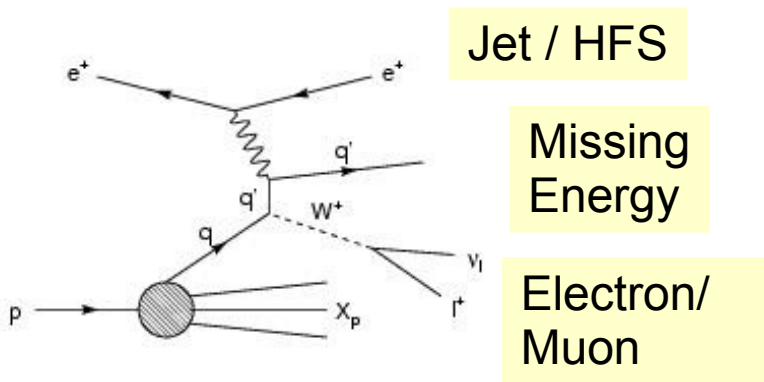

Anomalous Single Top Production



- At high P_T^X isolated leptons signature compatible to **anomalous single top production via FCNC**
- Study using effective couplings V_{tuZ} $K_{tu\gamma}$

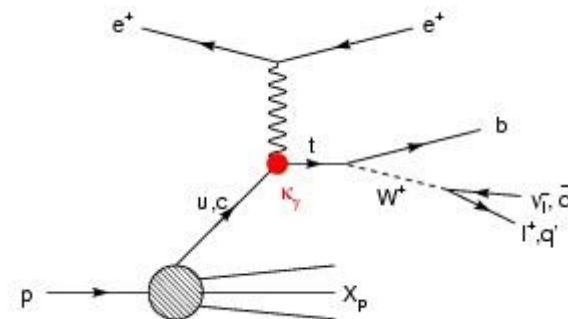

- Reconstruct *top* in isolated leptons sample
- Also include hadronic channel (3j)
- Some interesting events remain, but no significant excess observed
- Set limits on $K_{tu\gamma}$, V_{tuZ} (95% CL)

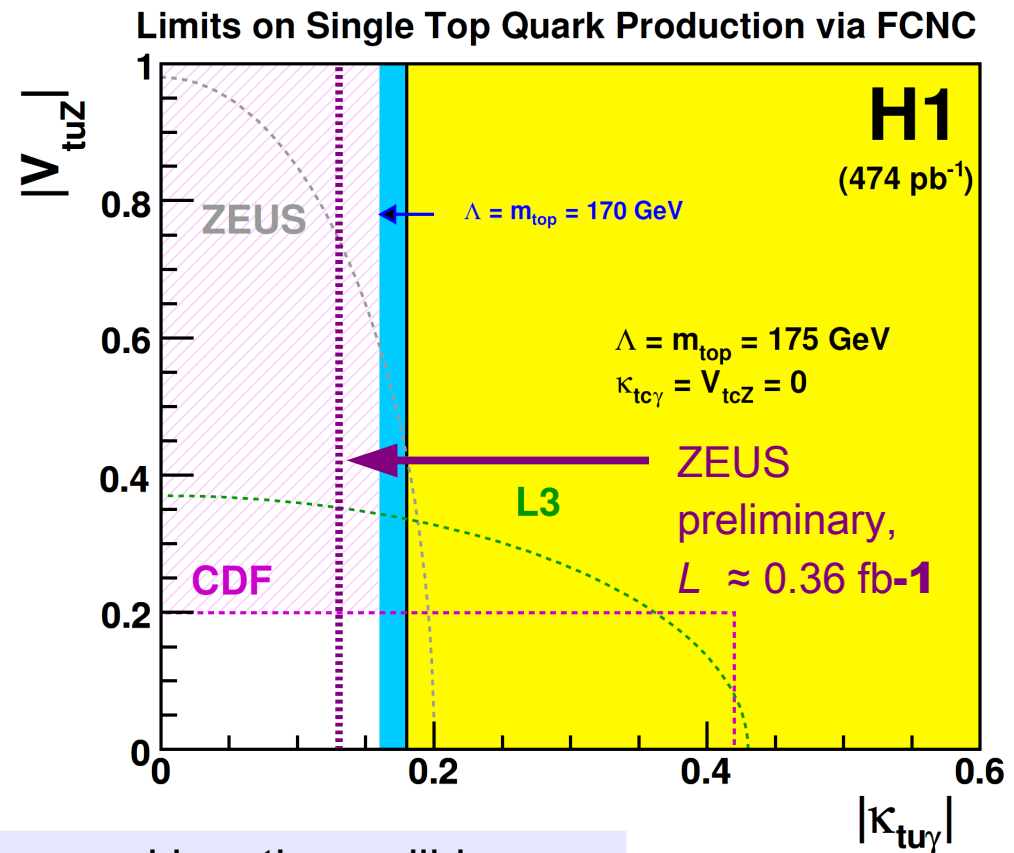
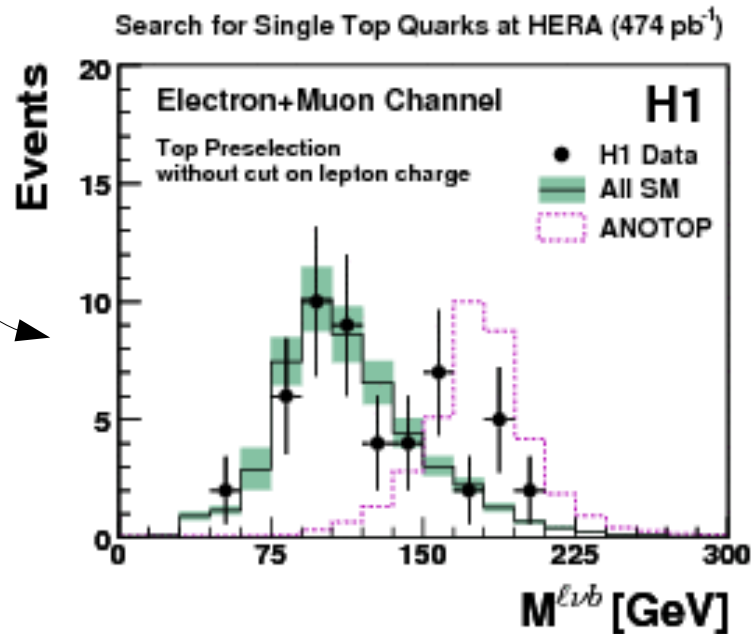

- HERA Limits on $K_{tu\gamma}$ explore domain not covered by other colliders
- H1 limits weaker than ZEUS preliminary due to events in signal region

Search for Excited Fermions

- Search for direct production of excited fermions – evidence for compositeness
- Use effective Lagrangian to describe excitation/deexcitation

(Tevatron q^* limits not shown, assume $f_s=1$)

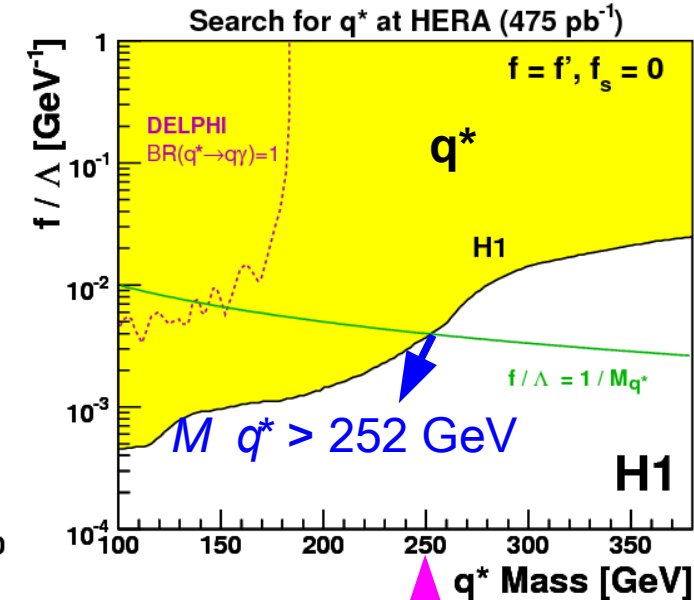
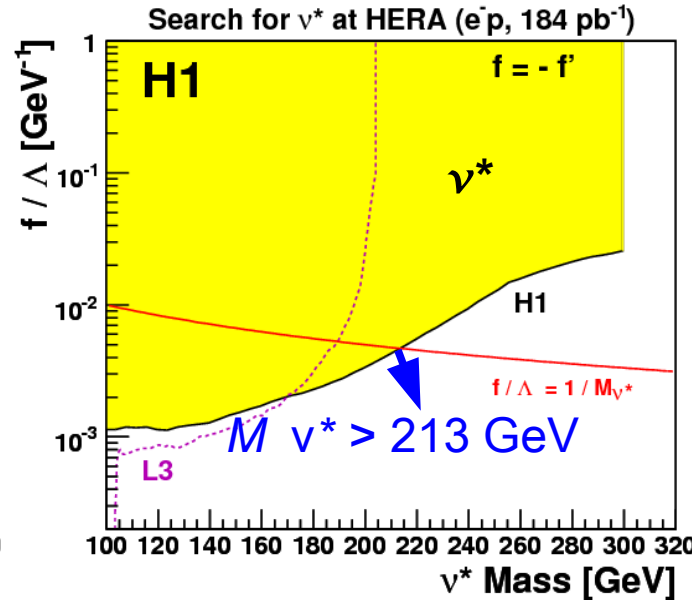
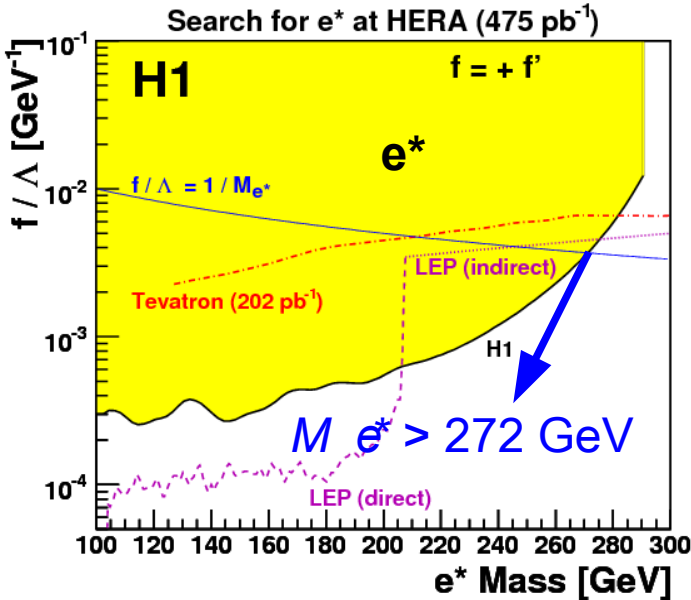

- Excited fermions decay to SM fermions and gauge bosons
- Leptonic and hadronic decay channels of gauge bosons
- No deviation from SM found – set limits f/Λ (m_{f^*}) at 95%CL
- f, f', f_s : couplings to gauge groups
- Λ : effective scale

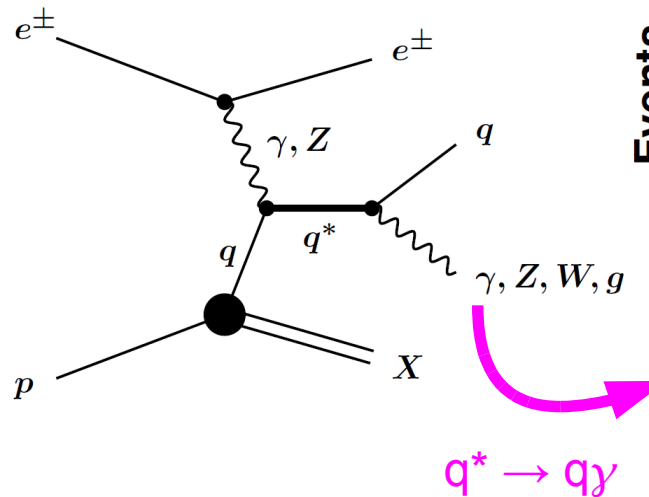

$q^* \rightarrow q\gamma$

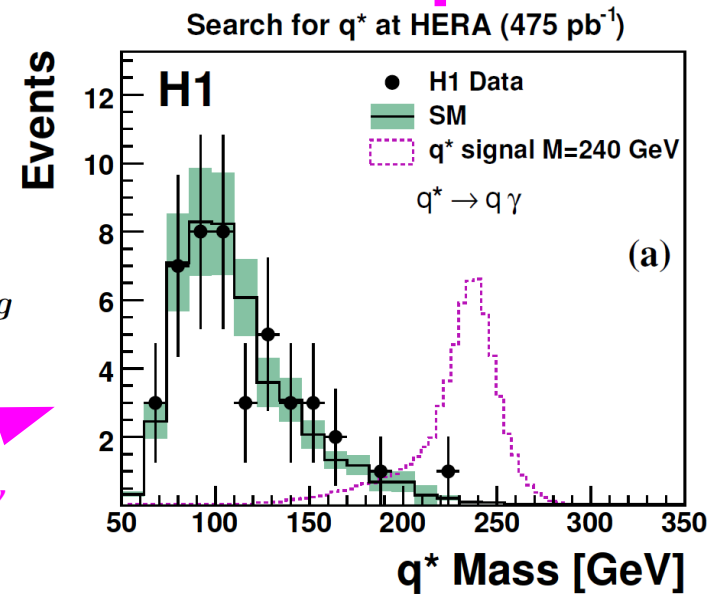

Search for Squark Production at HERA



Resonant production of single squarks in ep -collisions possible with R -Parity **Violating** Superpotential

$$R_P = (-1)^{3B+L+2S}$$

SUSY: $R_P = -1$

SM: $R_P = 1$

$$W_R = \frac{1}{2} \lambda_{ijk} L_i L_j \bar{E}_k + \lambda'_{ijk} L_i Q_j \bar{D}_k + \frac{1}{2} \lambda''_{ijk} \bar{U}_i \bar{D}_j \bar{D}_k$$

L: LH (s)leptons, **Q**: LH (s)quarks, **D**: RH down-type (s)quarks
 i, j, k generation indices (27 couplings)

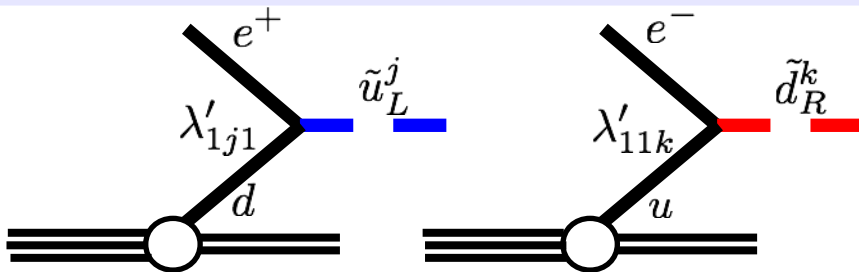

- Many decay modes possible (direct, cascade)
- All relevant 17 final states investigated
- Selections optimized to minimize expected limit
- Some examples for rec. inv. mass spectra:

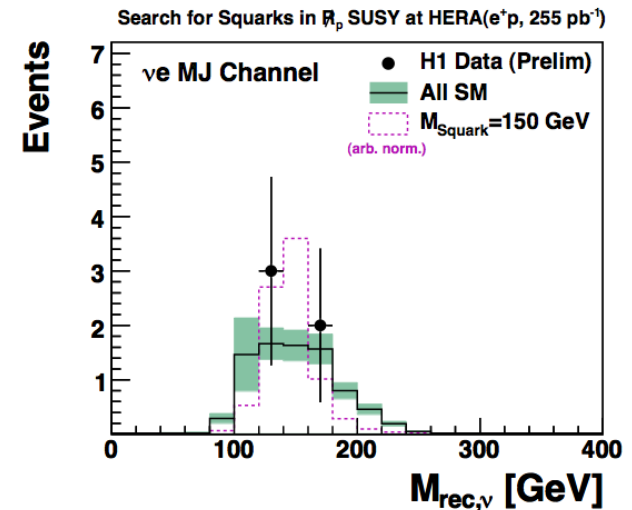
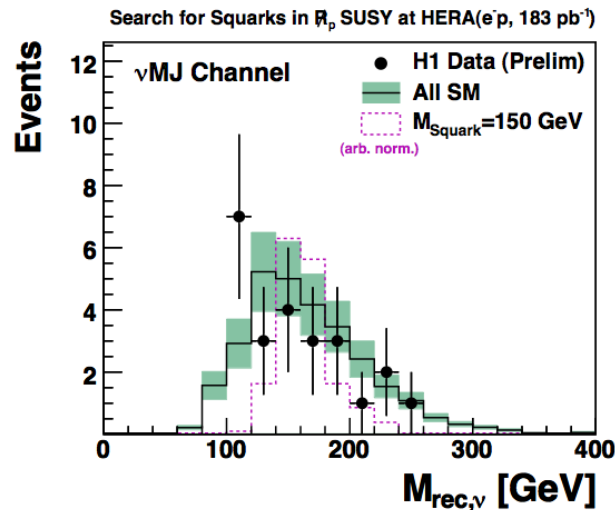
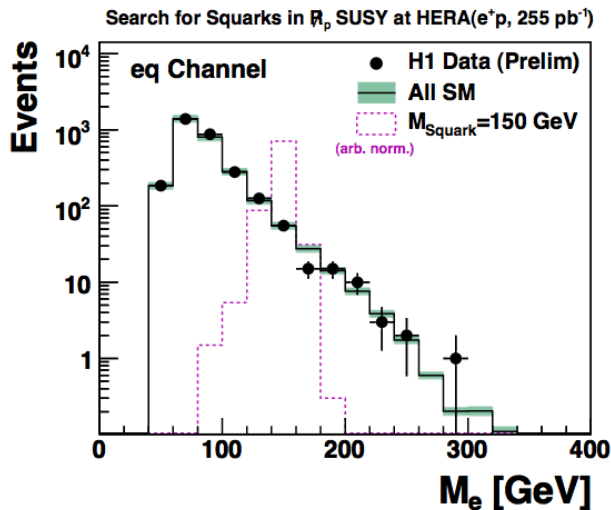

All investigated topologies in good agreement with SM exp.! → Set limits on R_p V SUSY models

Constraints on MSSM and mSUGRA



Scan of accessible MSSM parameter space

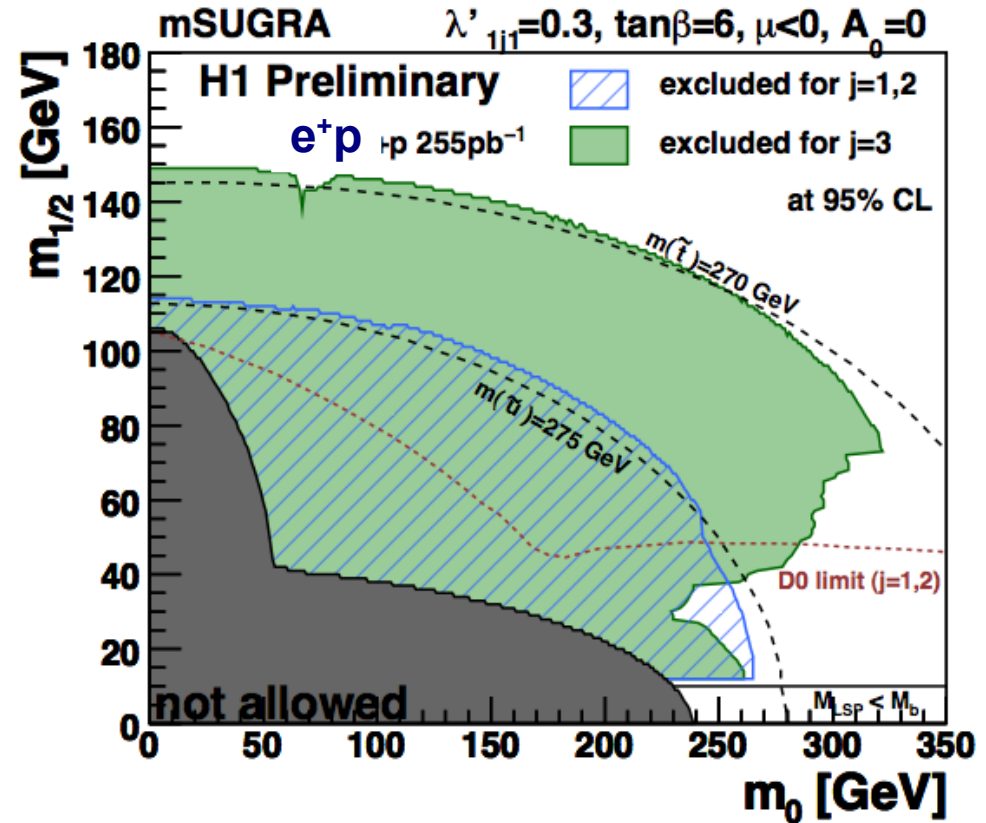
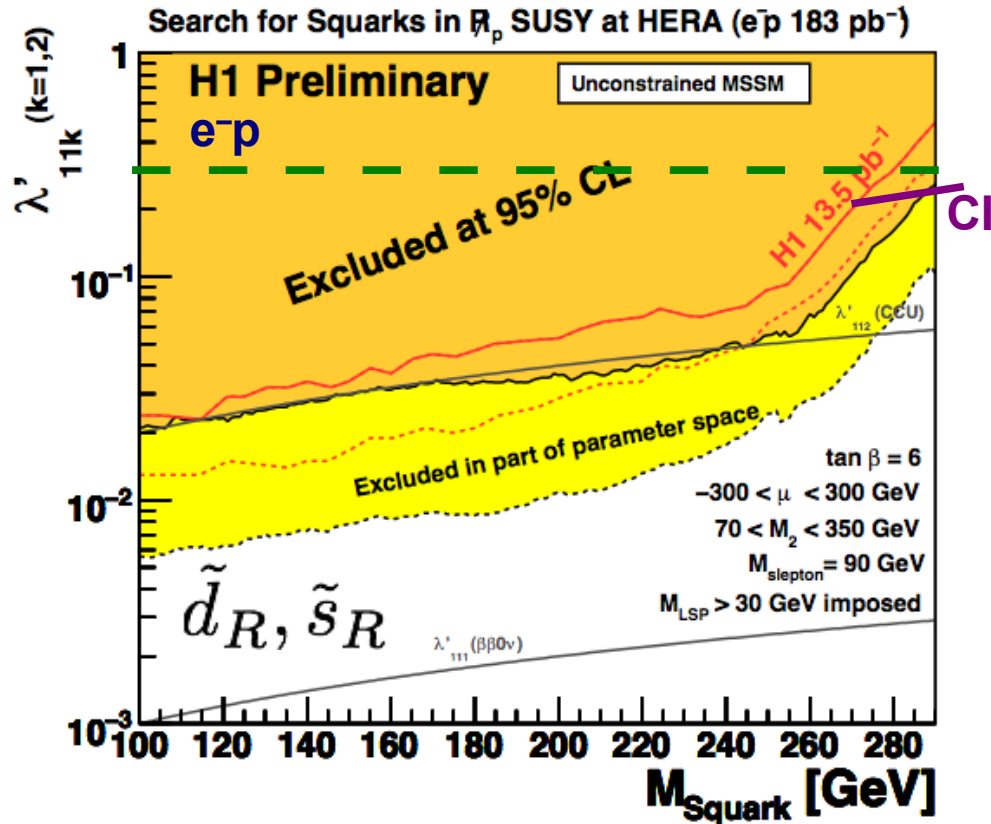

- For a Yukawa coupling $\lambda'_{11k} = 0.3$ (em. strength):
- Down-type squarks up to **290 GeV** excluded at 95%CL
- Complementary to indirect limits from CCU, $\beta\beta 0\nu$
- Similar results for

$$\tilde{u}_L, \tilde{c}_L, \tilde{b}_R, \tilde{t}_L$$

- Assuming mSUGRA () with coupling $\lambda'_{1j1} = 0.3$ (em. strength) indicated region excluded at 95% CL
- HERA limits at $\tan \beta = 6$ extend beyond D0 limits

- Searches for deviations from the SM in $e^\pm p$ data performed by H1 and ZEUS based on the full HERA dataset ($\sim 0.5 \text{ fb}^{-1}$ per experiment)
- Good description of NC DIS at high Q^2 allows to constrain many CI models inclusively and estimate a quark radius $R_q < 0.63 \cdot 10^{-18} \text{ m}$
- Most accessible final states investigated by the experiments
 - General Search and many optimised searches
 - Intriguing events observed, but overall no significant deviation from SM prediction
- Many models excluded up to (and beyond for CI-like interactions) center-of-mass energy:
 - Anomalous single top production
 - Excited Fermions $M_{e^*} > 272 \text{ GeV}, M_{\nu^*} > 213 \text{ GeV}, M_{q^*} > 252 \text{ GeV}$
 - Lepton-flavor violating Leptoquarks $M_{LQ} > 272\text{-}530 \text{ GeV}$
 - Squarks in RPV SUSY $u\text{-type } M_{sq} > 275 \text{ GeV}, d\text{-type } M_{sq} > 290 \text{ GeV}$
 $\lambda'_{1j1}, \lambda'_{11k} = 0.3$

- Excellent understanding of ep physics at $\sqrt{s}=320 \text{ GeV}$
- HERA limits remain competitive in regions not accessible at LEP, Tevatron (and not yet at LHC)

b a c k u p

Event Displays: LFV Candidates



H1 Candidate Event in the Search for Second Generation Leptoquarks

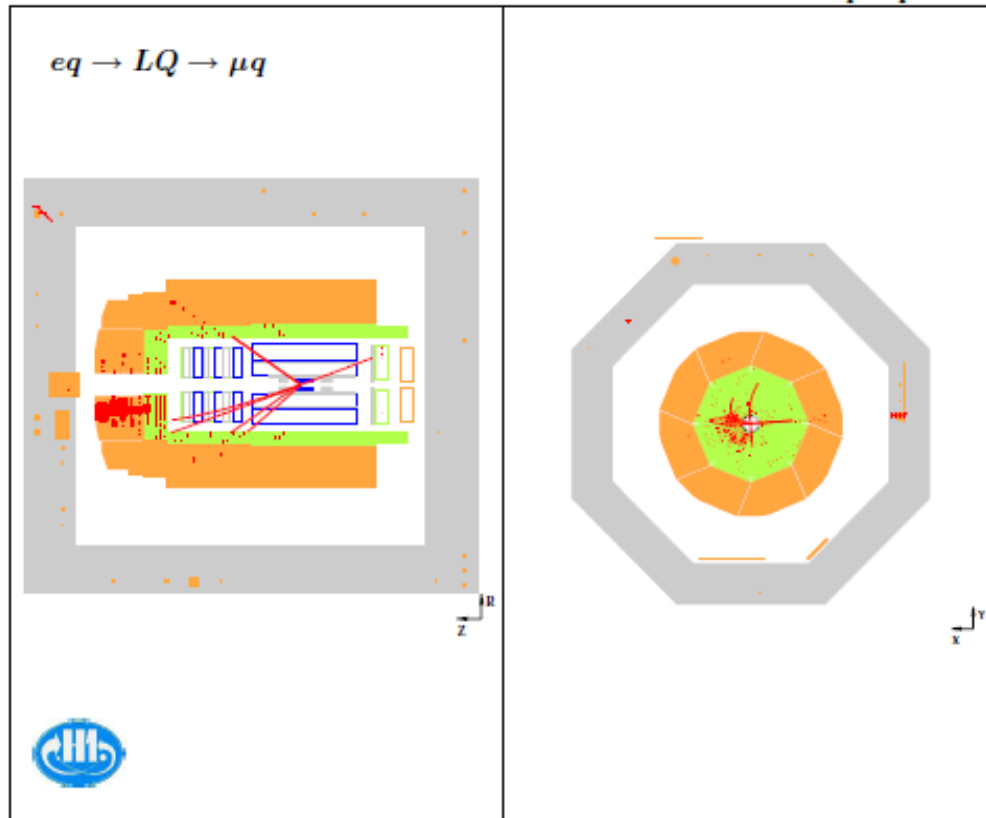

$ep \rightarrow \mu X$

$ep \rightarrow \tau X$

H1 Candidate Event in the Search for Third Generation Leptoquarks

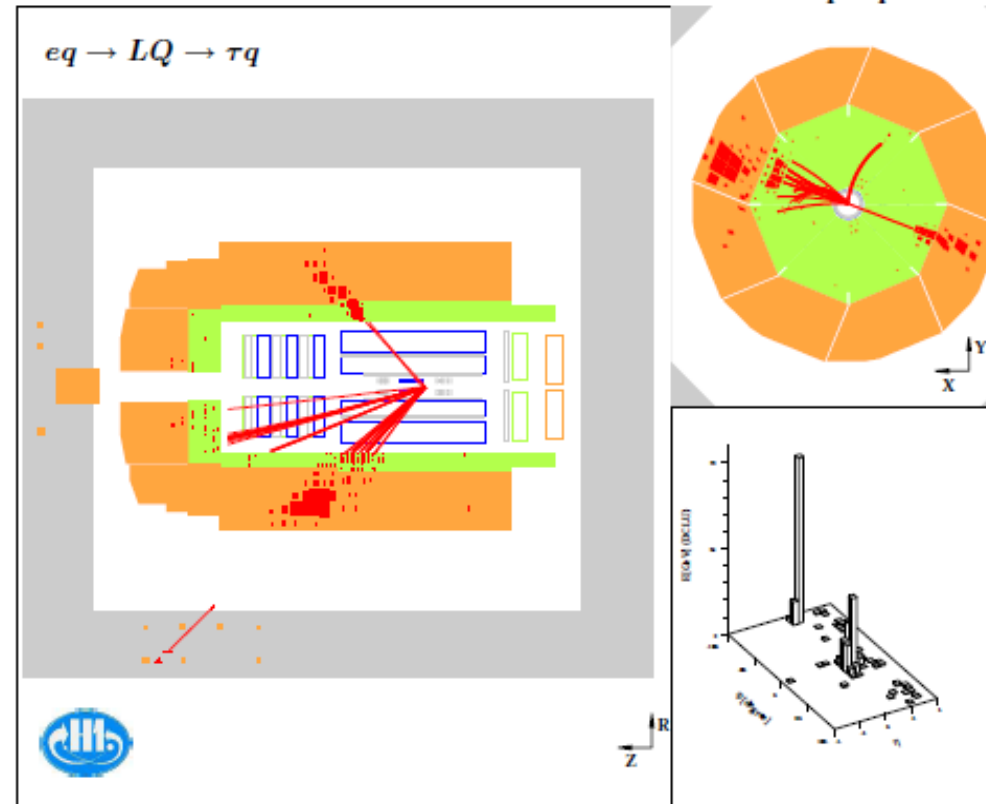

Search for 2nd generation Leptoquarks

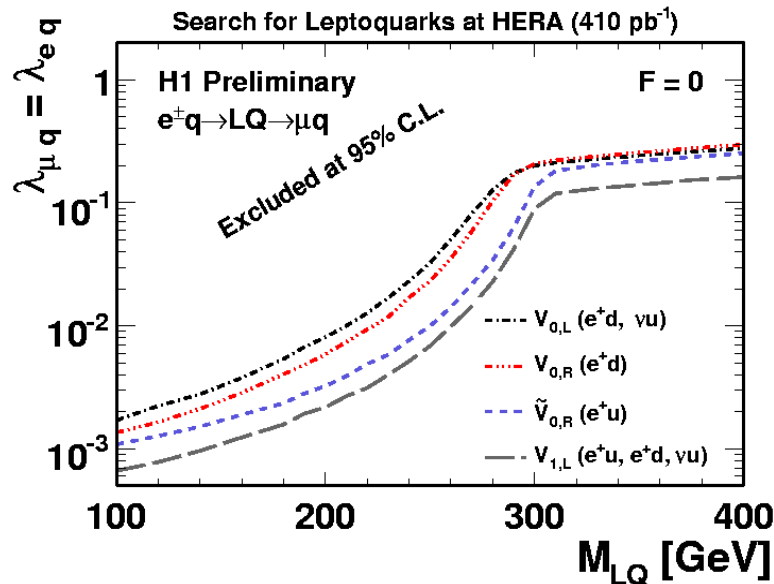
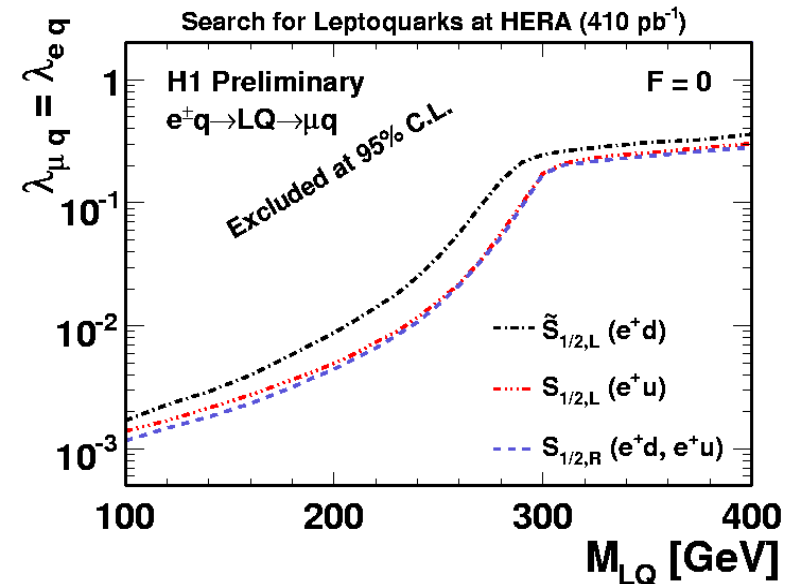

For
electromagnetic
strength $\lambda=0.3$
M_{LQ} < 304-530 GeV
can be ruled out

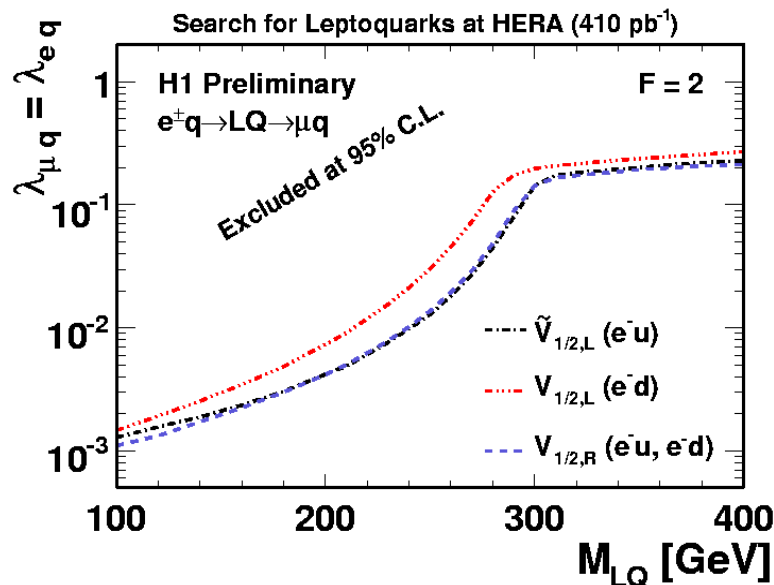
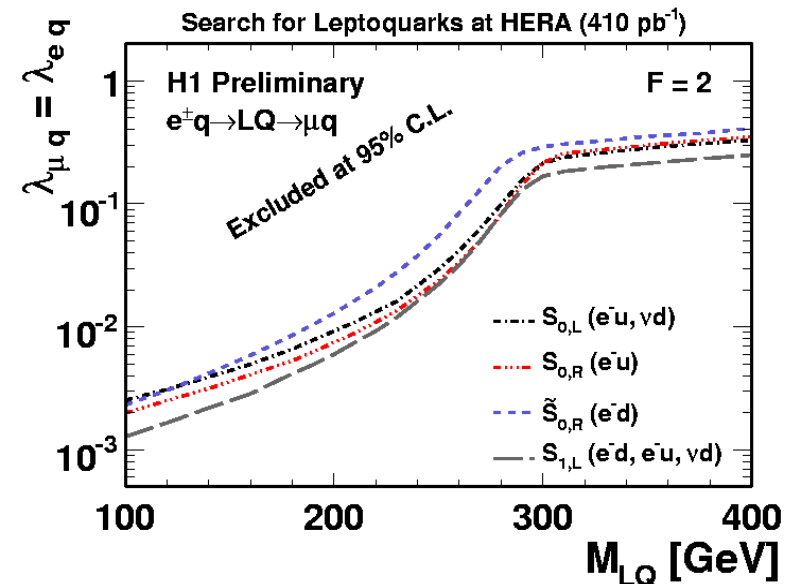

For scalar LQ,
 $\beta=0.5$
Tevatron limit
M_{LQ} > 259 GeV

Search for 3rd generation Leptoquarks

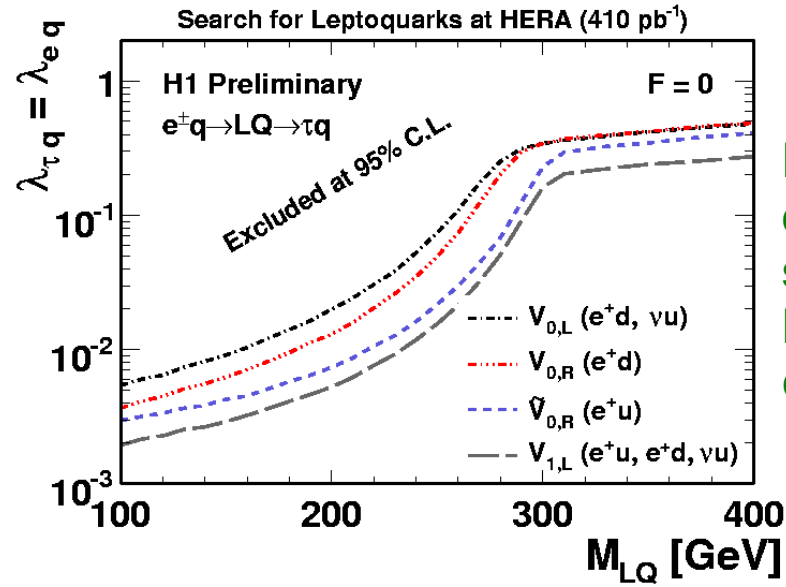
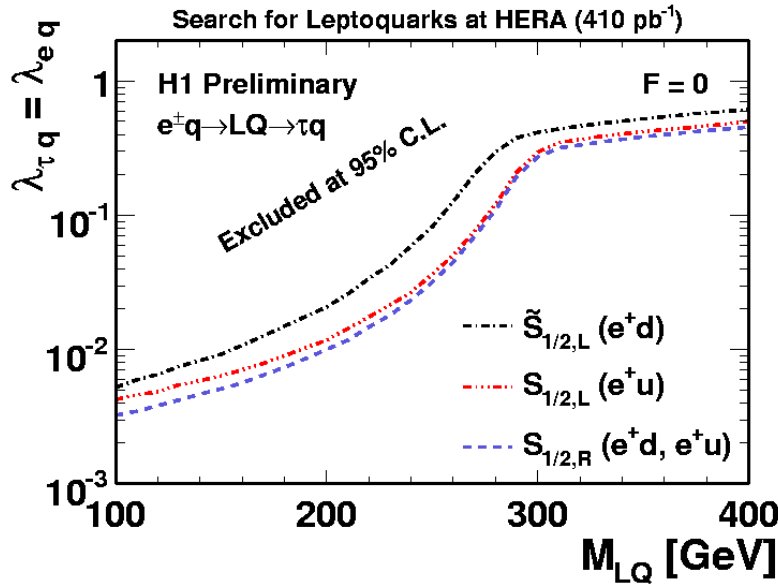

For
electromagnetic
strength $\lambda=0.3$
MLQ < 272-450 GeV
can be ruled out

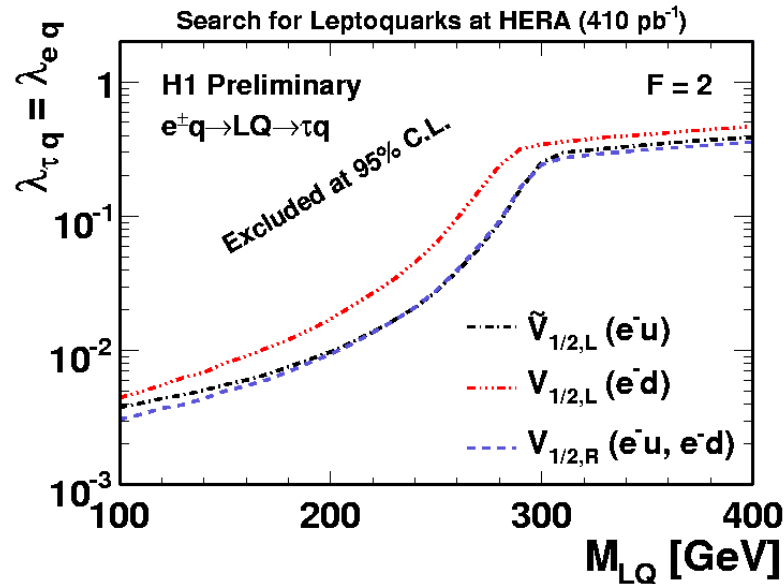
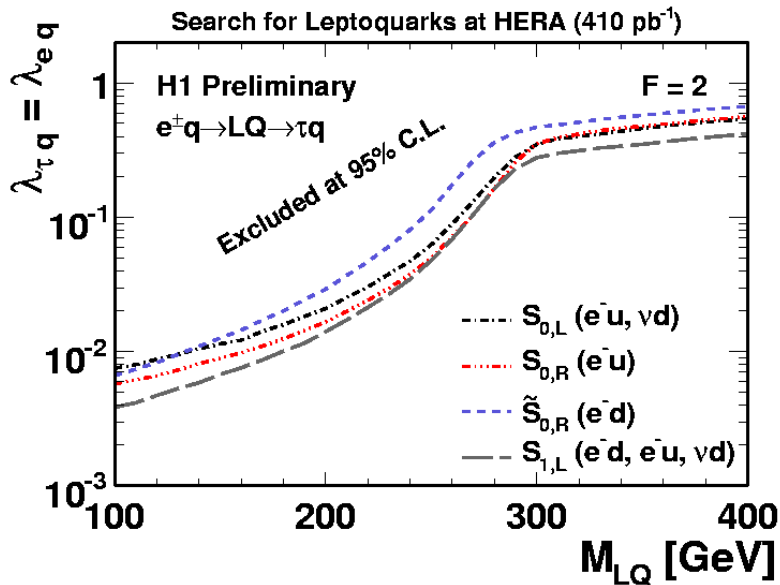

For scalar LQ,
 $\beta=0.5$
Tevatron limit
MLQ > 207 GeV

Search for RPV SUSY – Selection Results



Search for Squarks in RPV SUSY with H1 (Preliminary)					
Channel	e^+p (255 pb ⁻¹)		e^-p (183 pb ⁻¹)		Signal Efficiency
	Data	SM Expectation	Data	SM Expectation	
eq	2946	2899 ± 302	3121	3215 ± 336	30 – 40%
νq	-	-	2858	2983 ± 358	50 – 60%
eMJ (RC)	140	145.6 ± 21.3	147	157.7 ± 23.8	10 – 40%
eMJ (WC)	1	0.58 ± 0.36	0	1.3 ± 0.3	5 – 20%
νMJ	19	23.4 ± 5.8	24	28.9 ± 7.2	5 – 15%
$eeMJ$	2	1.7 ± 0.5	0	1.5 ± 0.5	5 – 35%
$e\mu MJ$	0	0.03 ± 0.03	0	0.03 ± 0.02	5 – 15%
νeMJ	5	8.2 ± 2.0	3	5.6 ± 1.2	5 – 40%
$\nu\mu MJ$	0	0.06 ± 0.03	0	0.04 ± 0.02	5 – 20%

Mass Distributions (e^-p , 183 pb^{-1})

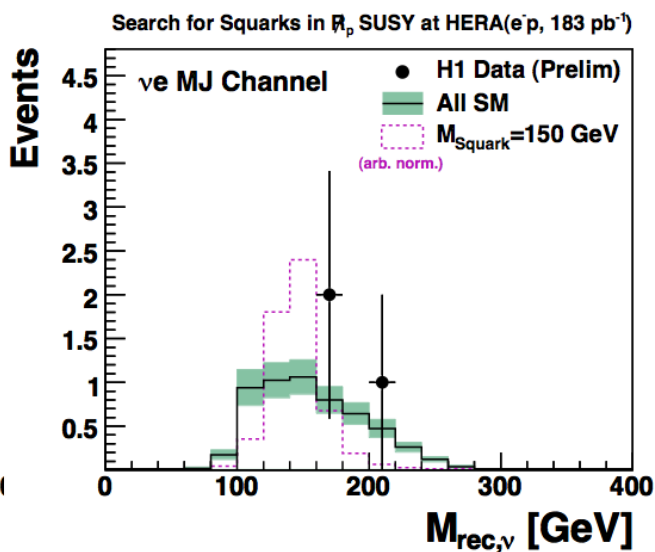
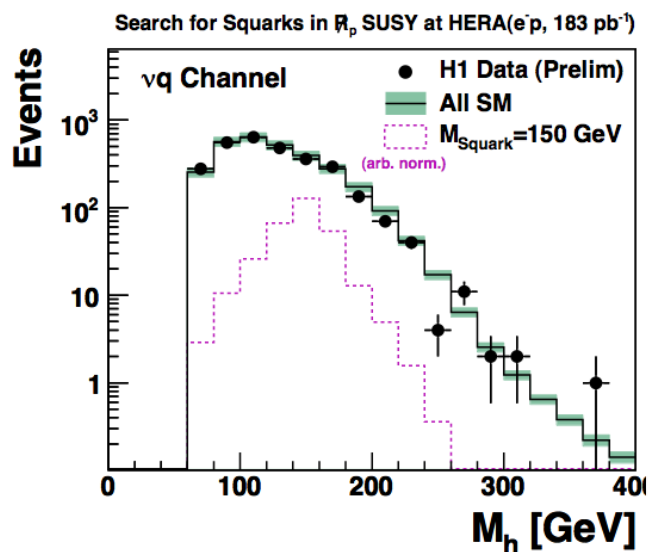
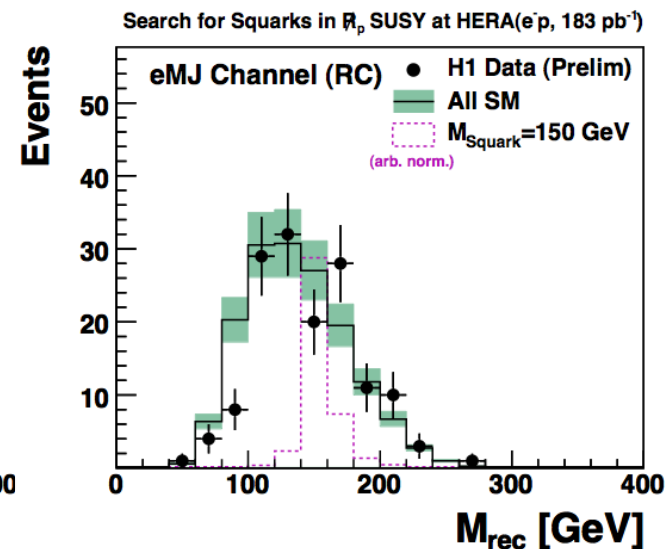
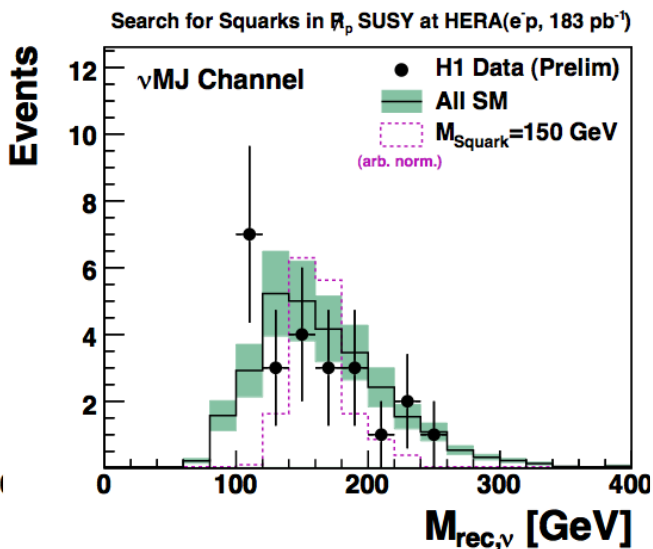
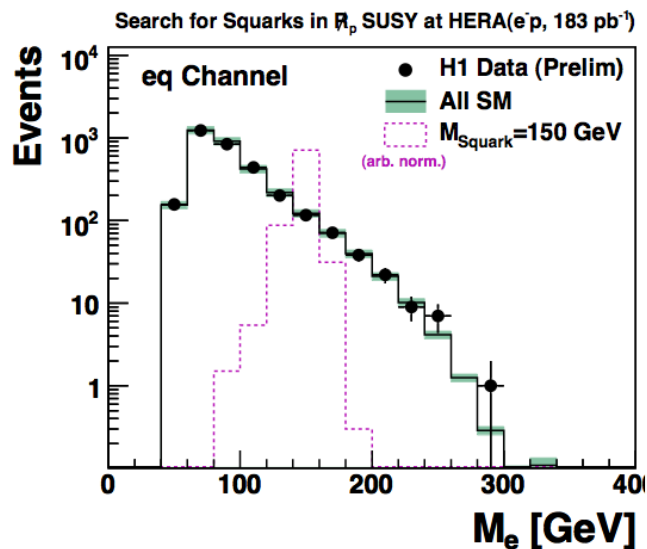

In e^-p and e^+p data
no significant
deviation from
SM background
observed

Mass Distributions (e^+p 255pb $^{-1}$)

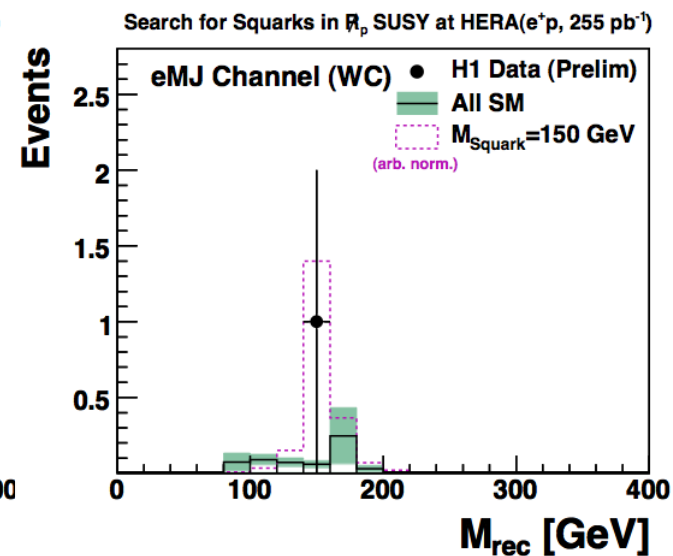
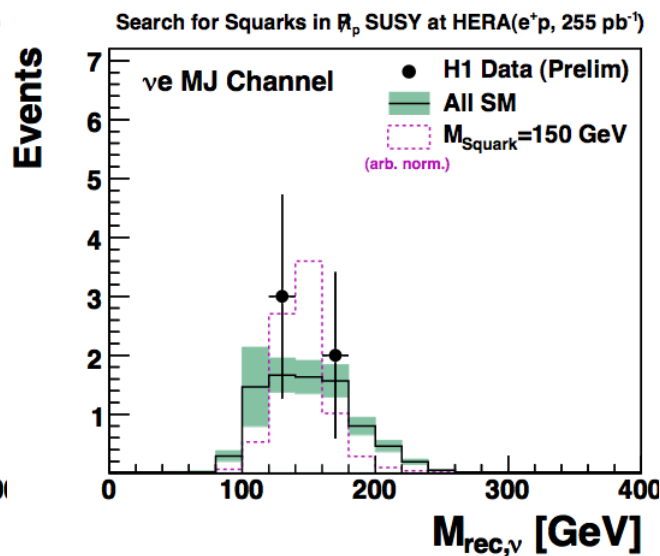
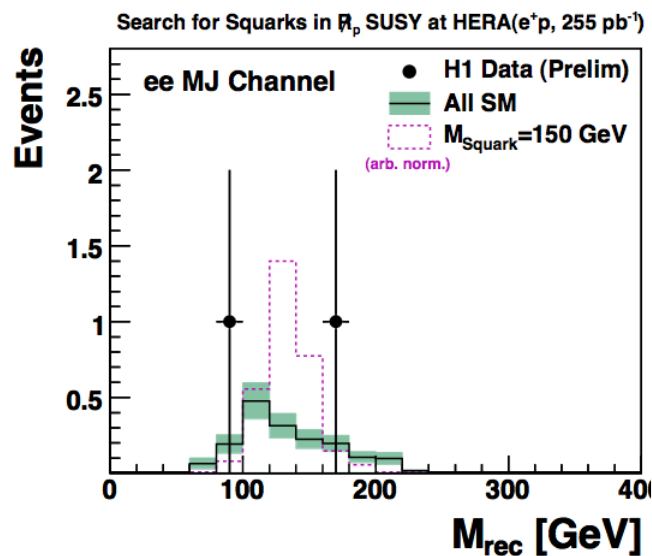
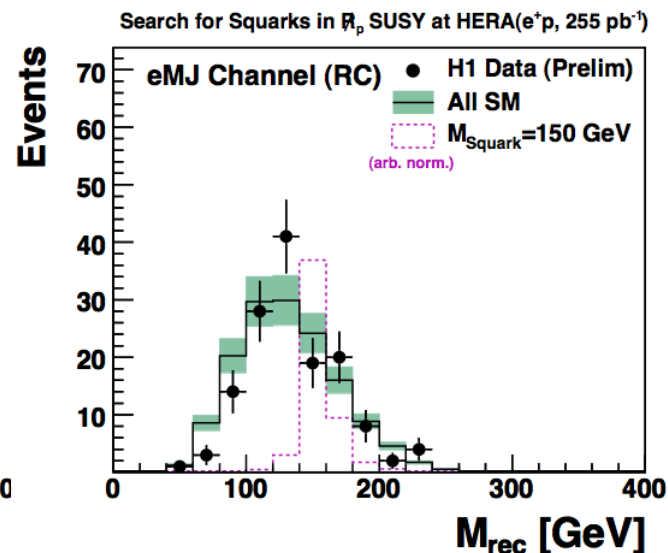
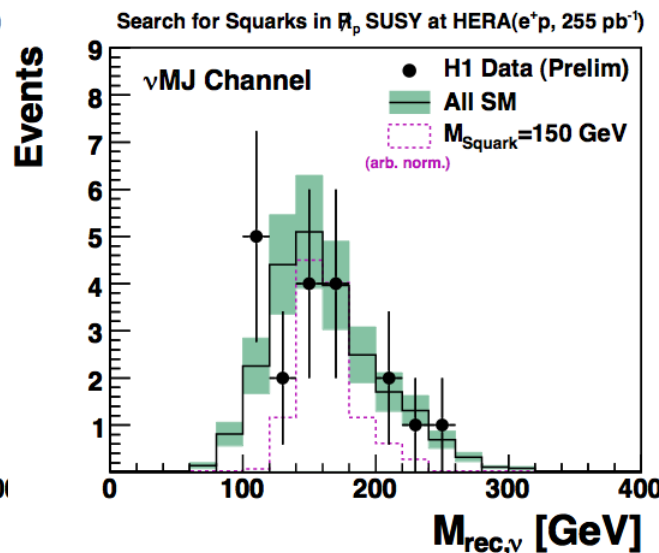
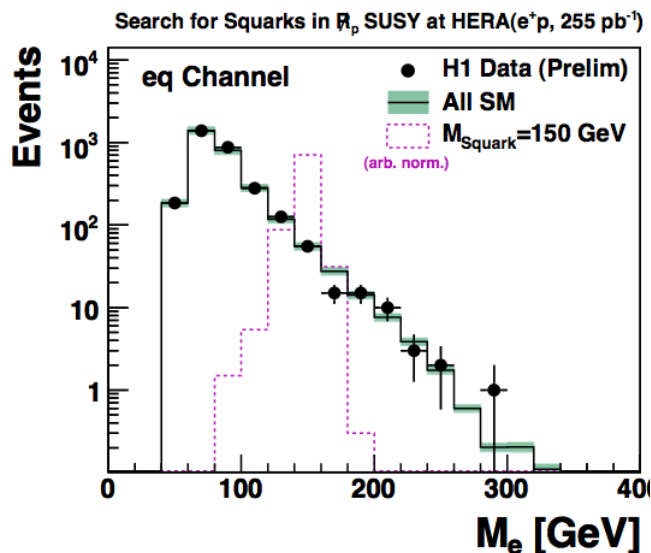

zino dominated neutralino

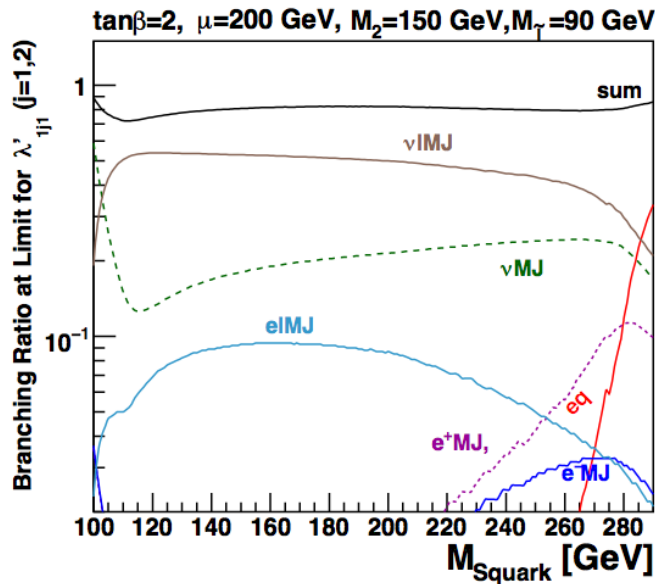
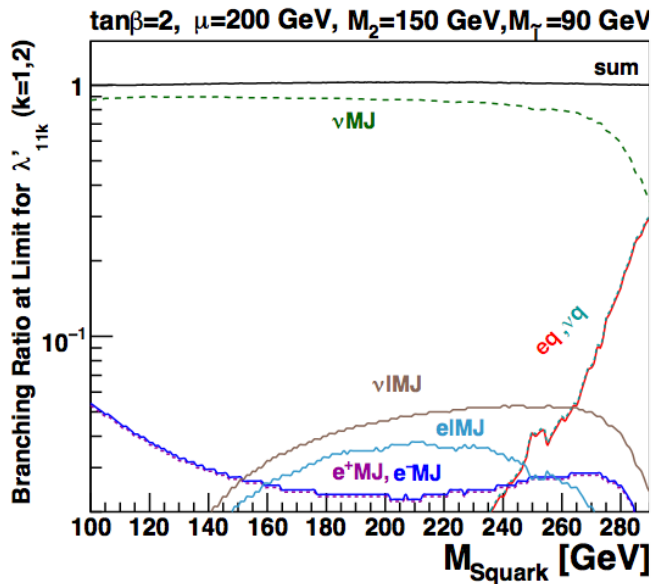
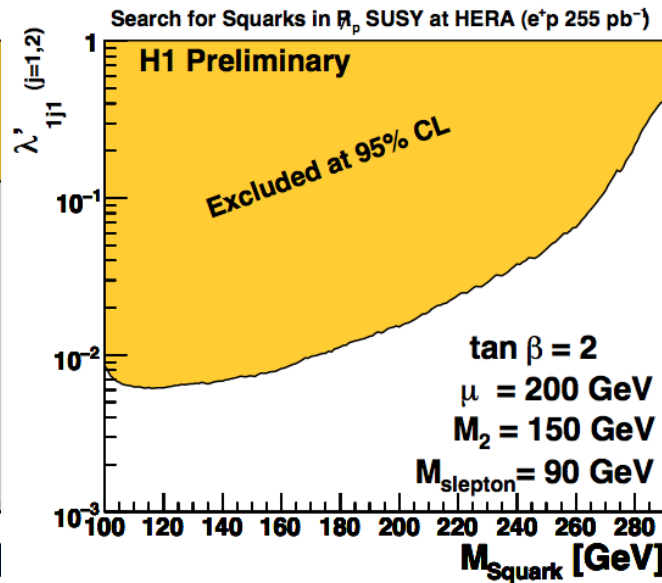
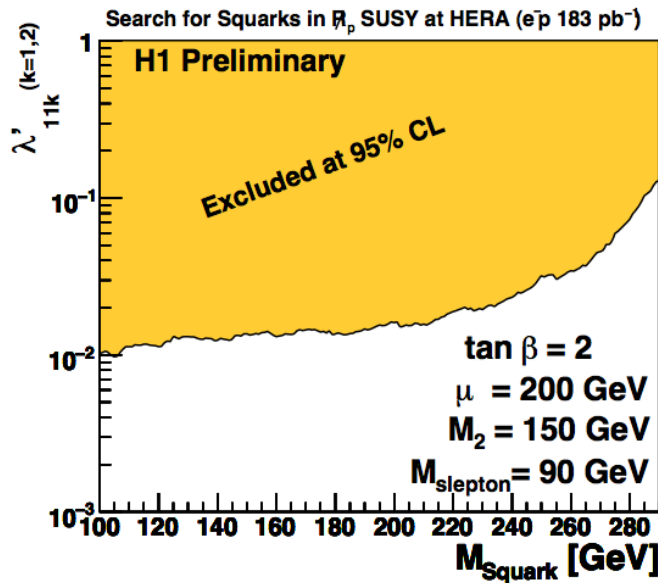

$\mu, \tan \beta, M_2$
determine REWSB

SUSY RPV Parameter Scan



$$\tilde{u}_L, \tilde{c}_L$$

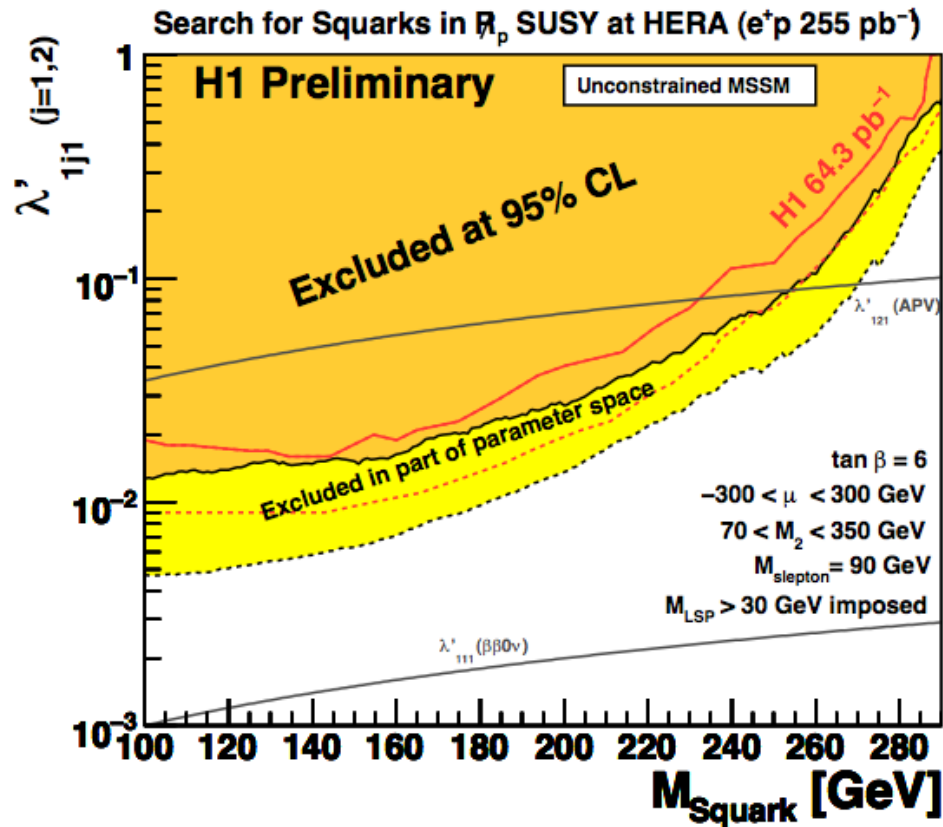

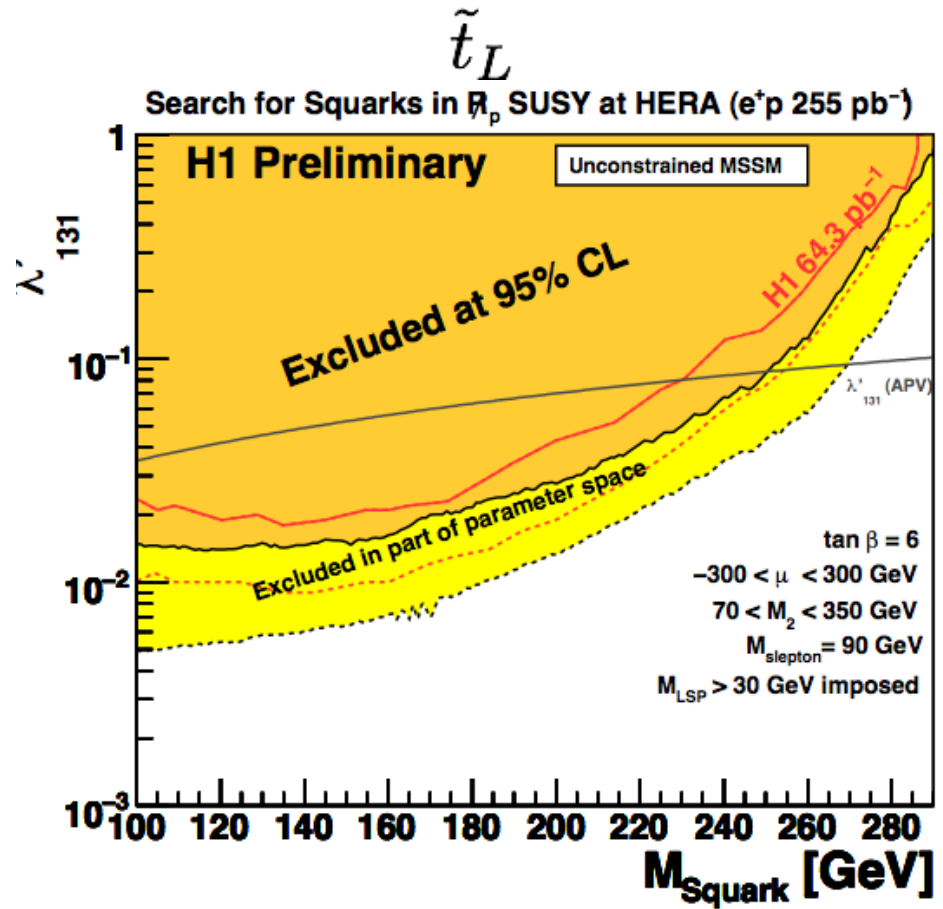
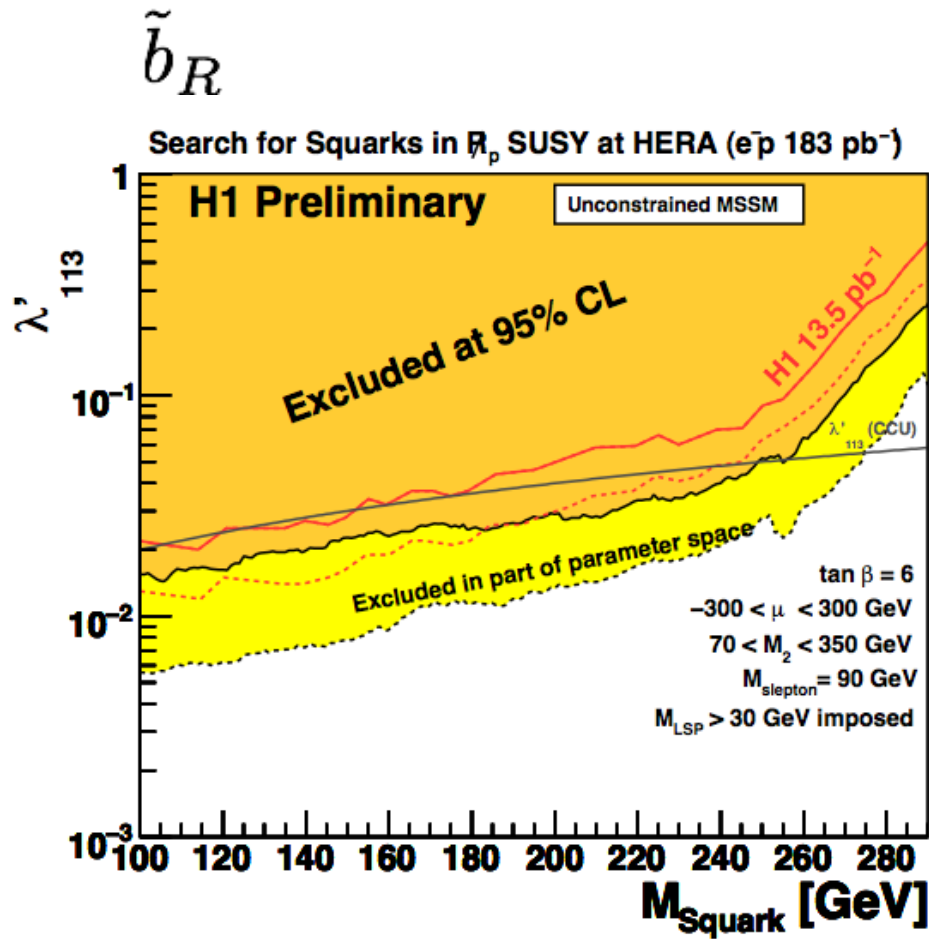

mSUGRA - Down-type Squarks

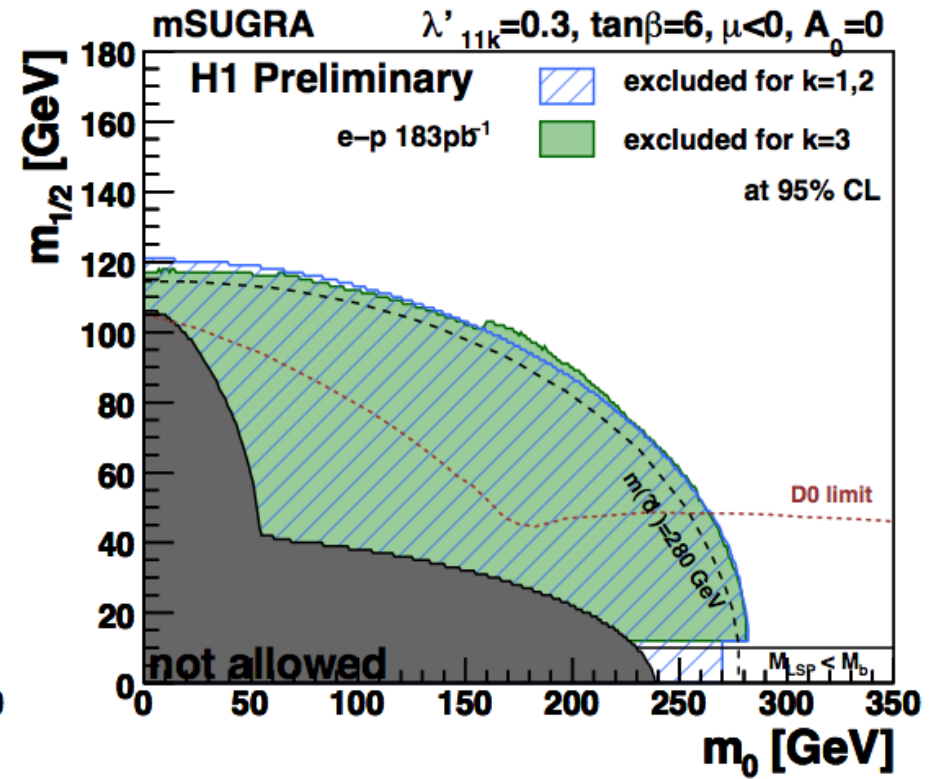
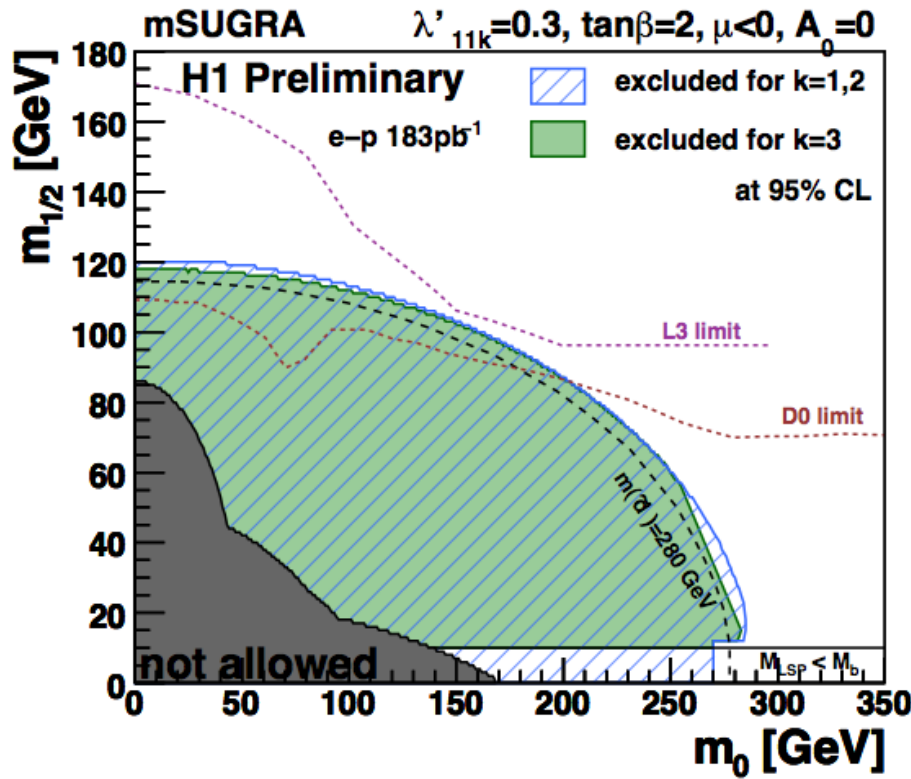

assuming a coupling strength: $\lambda'_{11k}=0.3$
 the indicated region can be excluded at 95% CL

mSUGRA - Up-type Squarks

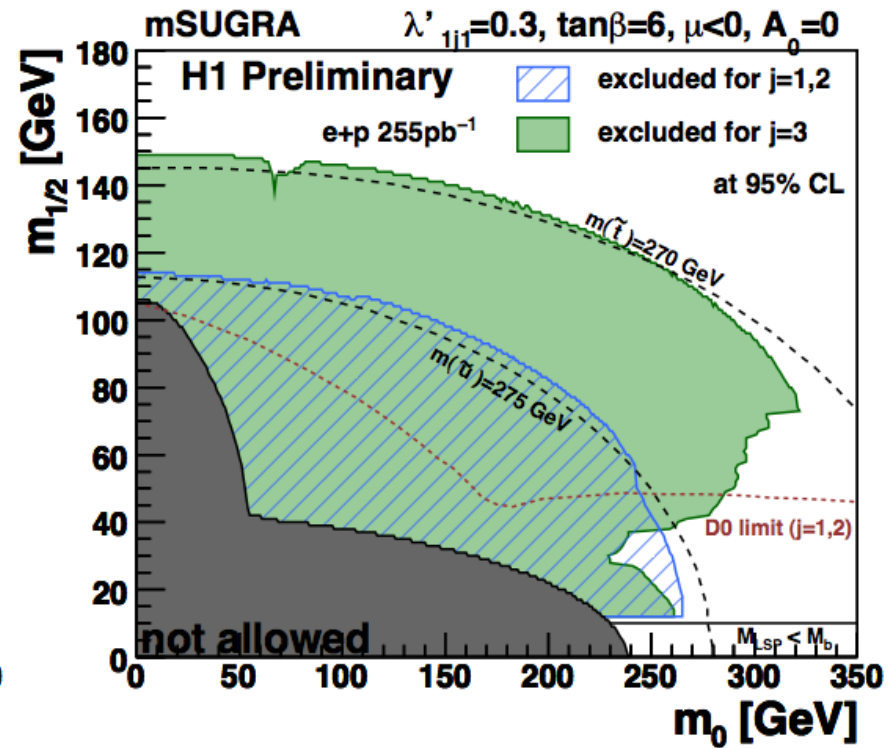
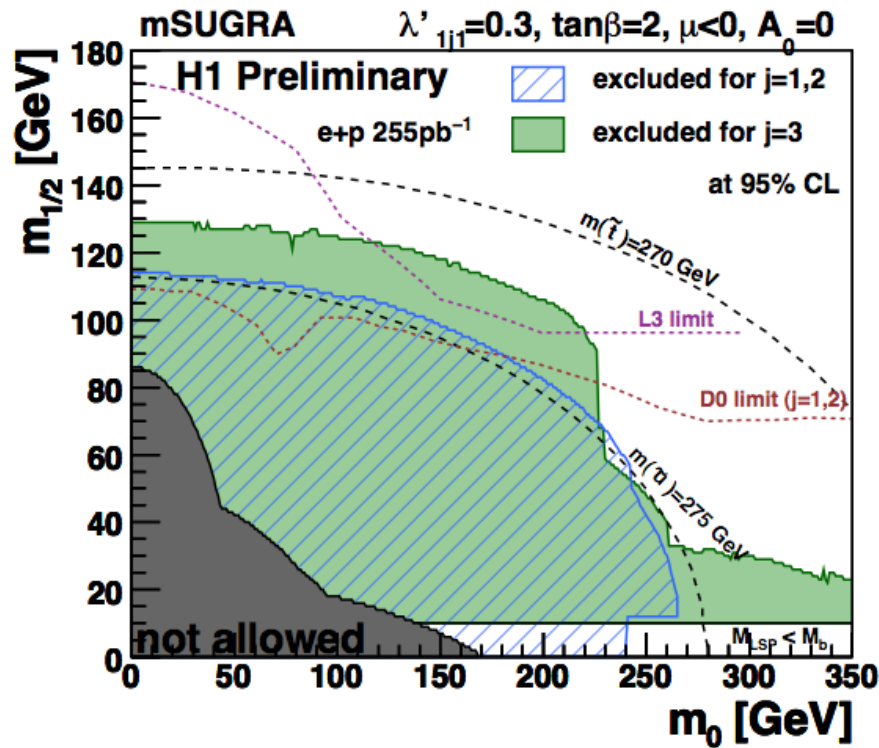

assuming a coupling strength: $\lambda'_{1j1}=0.3$
 the indicated region can be excluded at 95% CL

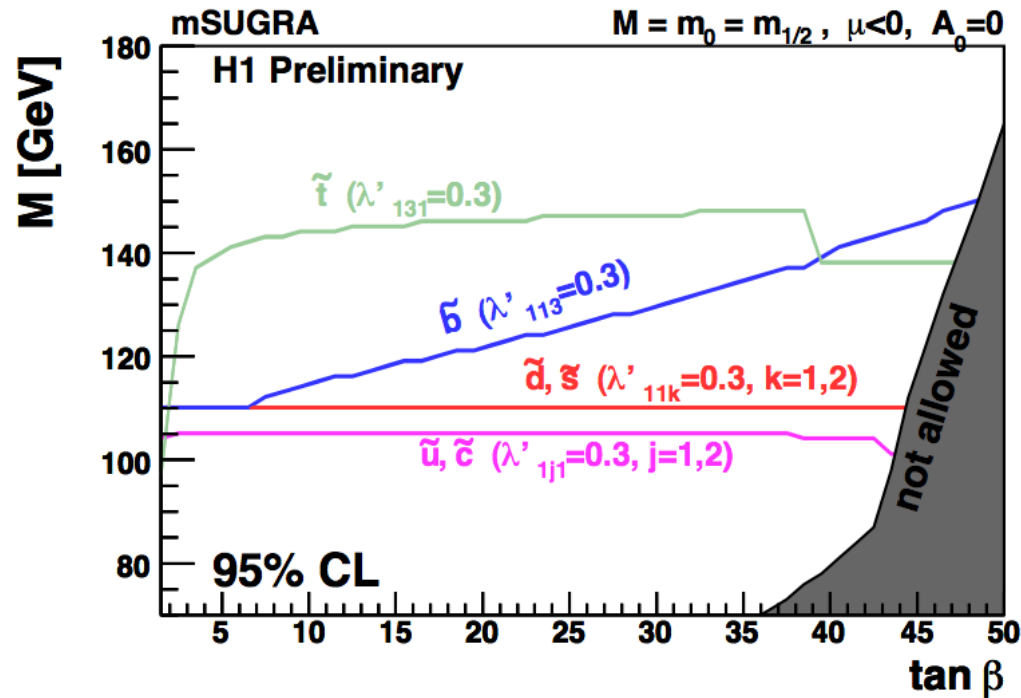

Strong mixing between stop (sbottom) states at higher $\tan \beta$ leads to dependence for third generation squarks.