

# Inelastic Production of $J/\psi$ Mesons at HERA

Michael Steder  
on behalf of the H1 collaboration



DIS conference, Florence  
20.04.2010



**DESY 09-225**, arXiv: 1002.0234[hep-ex] (submitted to EPJC)



## > HERA accelerator

- ep collider

$$\sqrt{s_{ep}} \approx 318 \text{ GeV}$$

- data taking : 1991-2007
- int. luminosity:  $1 \text{ fb}^{-1}$  (H1 + ZEUS)

## > H1 detector

- asymmetric instrumentation

$$E_p \gg E_e$$

- $4\pi$  multi purpose detector

tracking system

em. calorimeter

had. calorimeter

solenoid

return yoke / muon detector

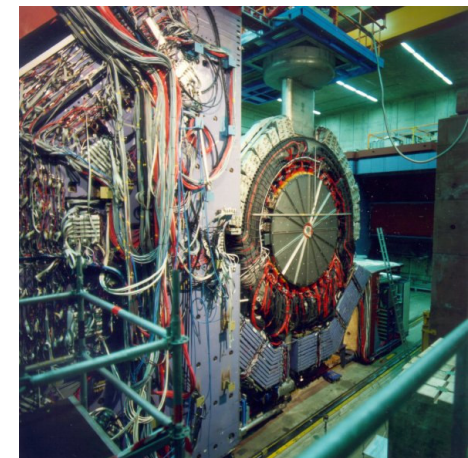
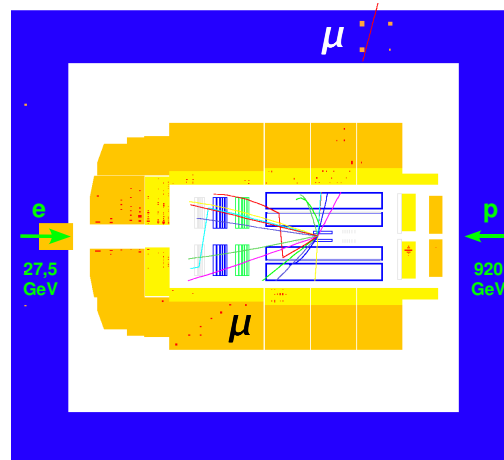

- > Center of mass energy

$$s = (P + k)^2$$

- > Effective mass in  $\gamma p$  system

$$W_{\gamma p}^2 = (P + q)^2$$

- > Photon virtuality

$$Q^2 = -q^2 = 4 \cdot E_e E_{e'} \cdot \cos\left(\frac{\theta_{e'}}{2}\right)$$

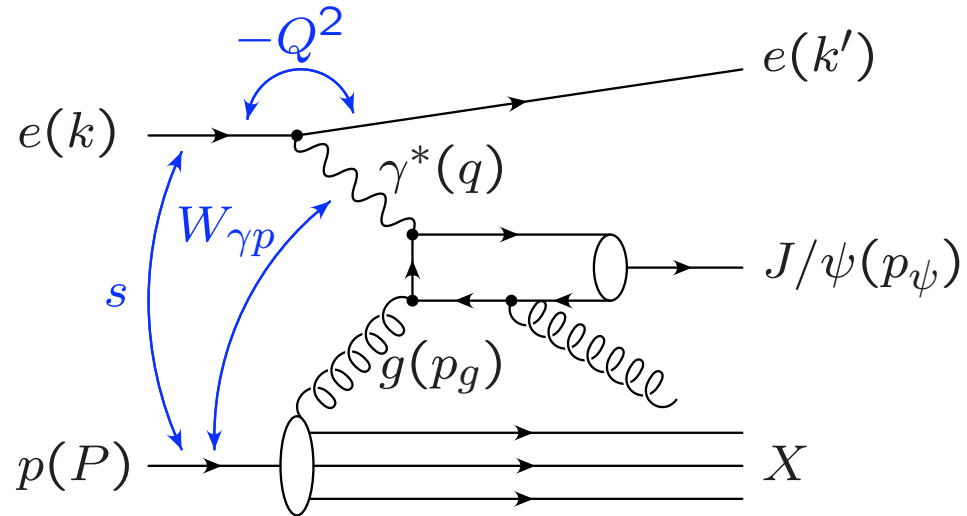

- >  $Q^2 \approx 0 \text{ GeV}^2$ : Photoproduction ( $\gamma p$ )
  - photon quasi real
  - scattered electron escapes undetected
- >  $Q^2 > 3.6 \text{ GeV}^2$ : Electroproduction (DIS)
  - large scattering angle
  - electron detected in main calorimeters

## > Inelastic Production

- quark pair from boson gluon fusion (BGF)
- radiation of gluons  
→ high track multiplicities

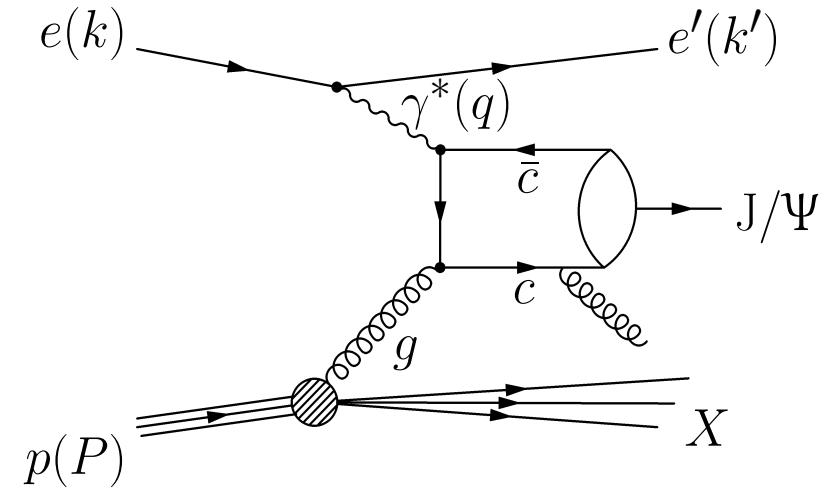

## > Diffractive Production

- much larger cross section
- no exchange of quantum numbers
- nothing beside J/ $\psi$  meson is produced  
→ only decay lepton tracks

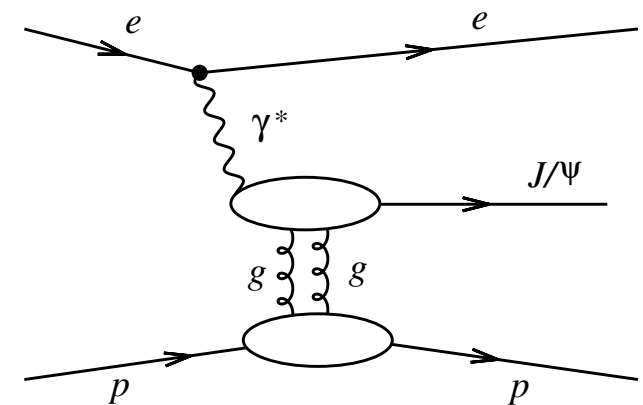



## > Inelastic Production

- quark pair from boson gluon fusion (BGF)
- radiation of gluons  
→ high track multiplicities

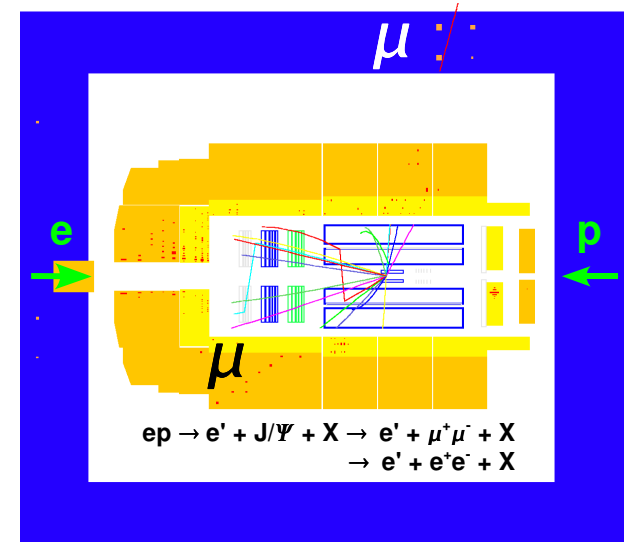

## > Diffractive Production

- much larger cross section
- no exchange of quantum numbers
- nothing beside J/ $\psi$  meson is produced  
→ only decay lepton tracks

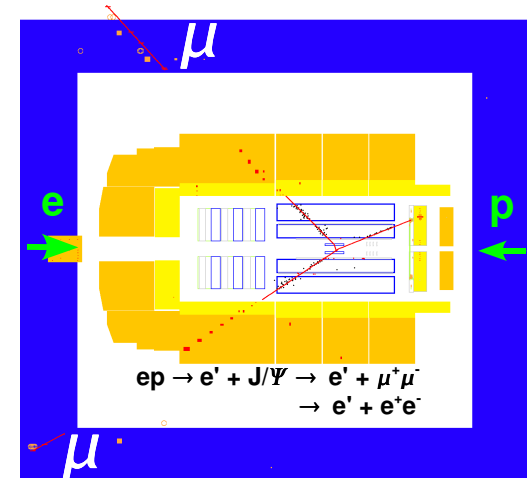

- Used to distinguish production processes
- Fraction of  $\gamma$  energy transferred to J/ψ
  - in proton rest frame
- Diffraction
  - full photon energy to J/ψ  
→  $z \approx 1$
- Inelastic Production
  - whole elasticity range
  - increasing track multiplicity towards low  $z$   
→ larger combinatorial background

$$z = \frac{P_\psi \cdot P}{q \cdot P} = \frac{E_\psi}{E_{\gamma^*}} \quad (\text{in proton rest frame})$$

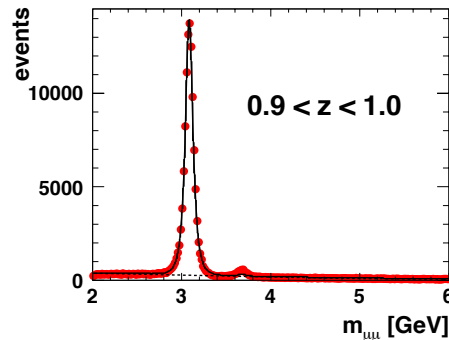
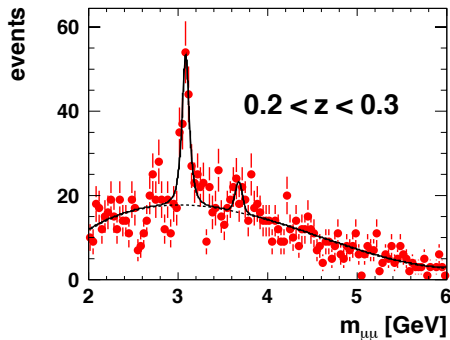
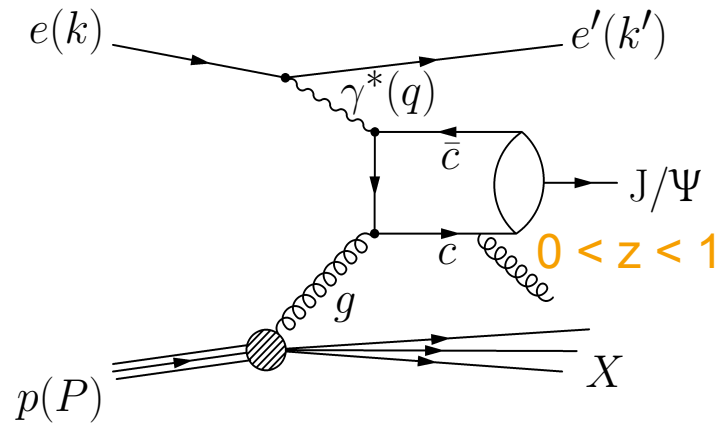
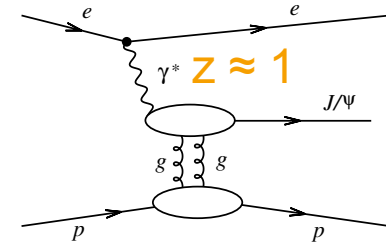

## > Color Singlet Model (CSM)

LO: Berger et al, Baier et al., 1981  
 NLO (direct): Krämer, Zerwas et al., 1995

- radiation of a 'hard' gluon

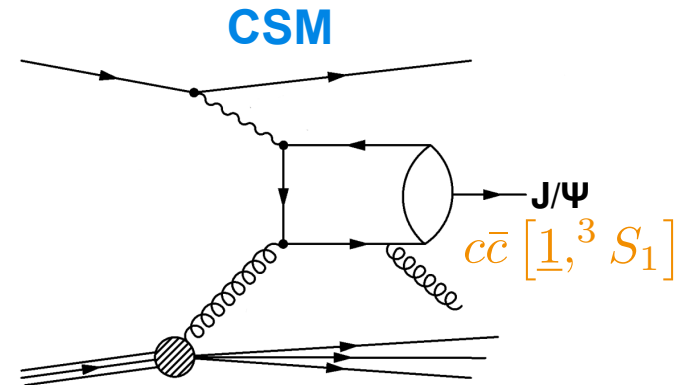

## > Color Octet Model (NRQCD)

LO: Bodwin, Braaten, Lepage, 1995  
 NLO ( $\gamma p$ ): Butenschön, Kniehl, 2009

$$\sigma(\mathbf{J}/\Psi + \mathbf{X}) = \sum_{\mathbf{n}} \hat{\sigma}(c\bar{c}[\mathbf{n}] + \mathbf{X}) \times \text{LDME}[\mathbf{n}]$$

- radiation of 'soft' gluons
- contains CSM
- LDME obtained from fit to Tevatron data  
 → expected to be universal

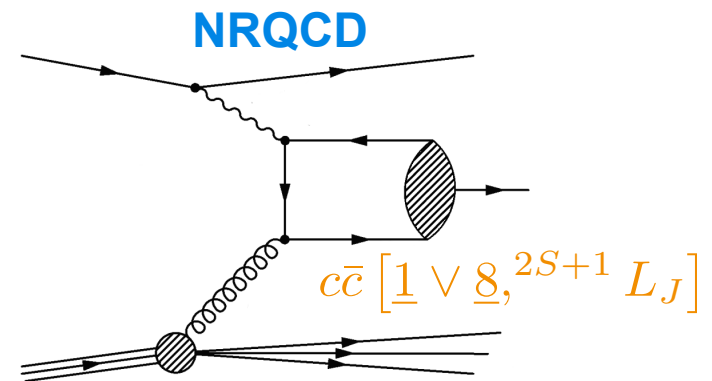

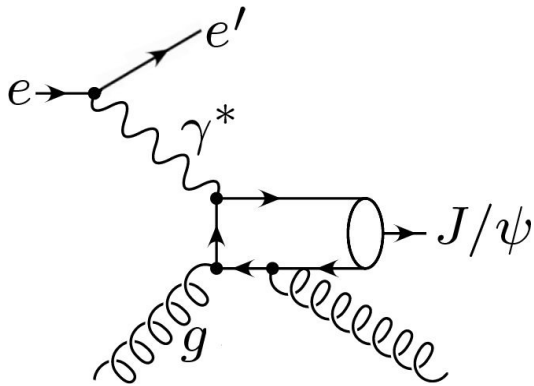

## > Electroproduction

- $\mathcal{L} = 315 \text{ pb}^{-1}$
- $3.6 < Q^2 < 100 \text{ GeV}^2$
- $P_{T,\psi^*} > 1 \text{ GeV}$  ( $P_{T,\psi}$  in  $\gamma p$  rest system)
- $60 < W_{\gamma p} < 240 \text{ GeV}$
- $0.3 < z < 0.9$
  
- syst. uncertainty: 9.0%

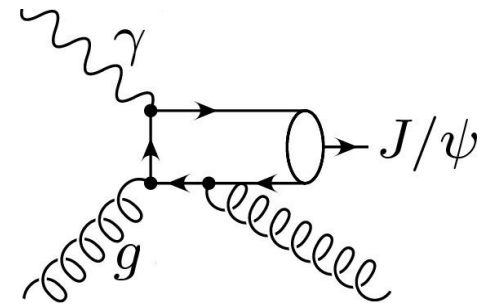

## > Photoproduction

- $\mathcal{L} = 165 \text{ pb}^{-1}$
- $Q^2 < 2 \text{ GeV}^2$
- $P_{T,\psi} > 1 \text{ GeV}$
- $60 < W_{\gamma p} < 240 \text{ GeV}$
- $0.3 < z < 0.9$
  
- syst. uncertainty: 8.5%

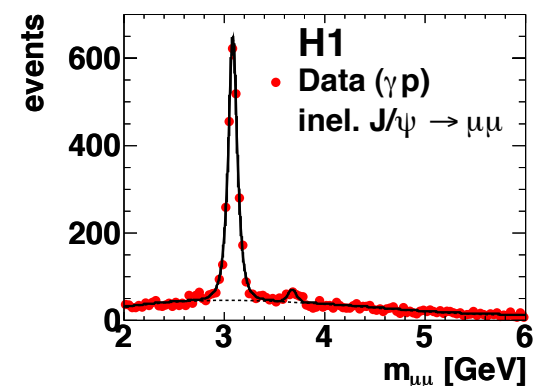
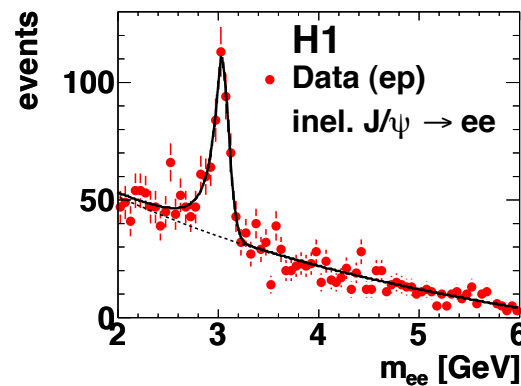
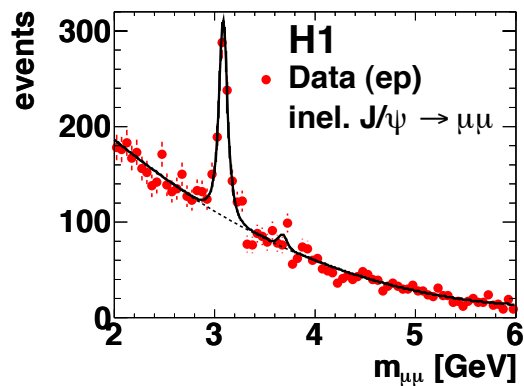



- Inelastic  $\psi(2S)$  mesons: 15-20%
  - equally distributed in all bins
  - not shown
  
- B hadrons: 3.6%
  - lowest  $z$  bin: 20%
  
- Diffractive  $\psi(2S)$  mesons: 1.3%
  - highest  $z$  bin: 5%
  
- Cross sections are **not** corrected for these contributions

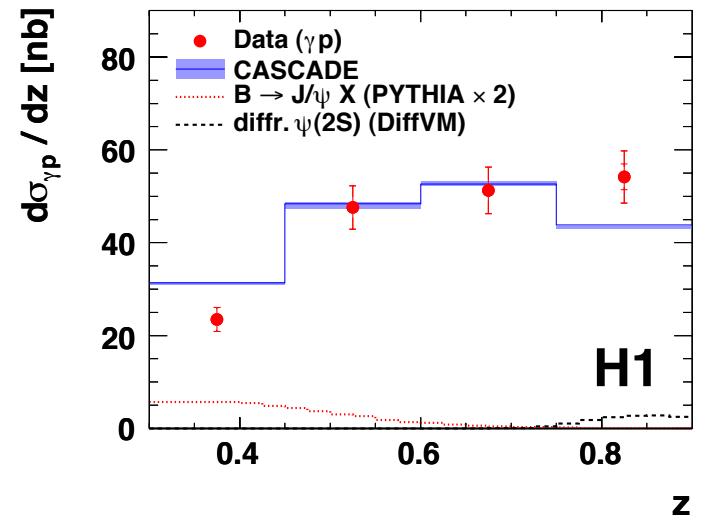
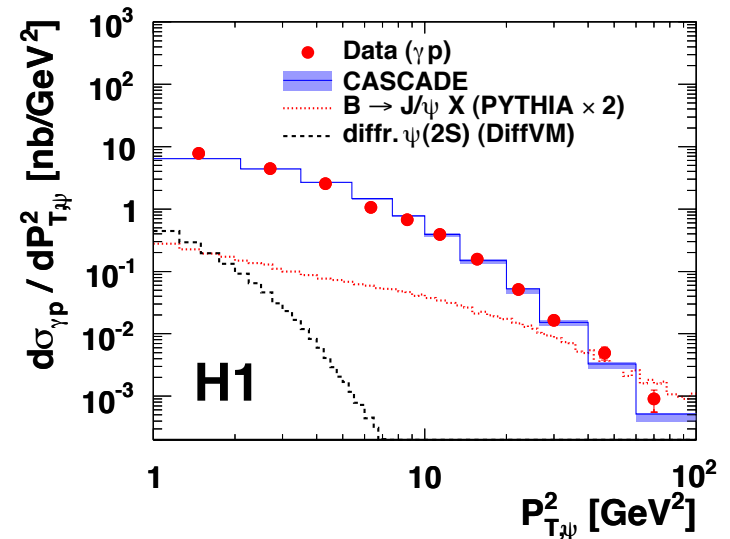

- CSM NLO calculation exists since 1995
  - direct photoproduction only
  - very large NLO corrections
  - good description of HERA data

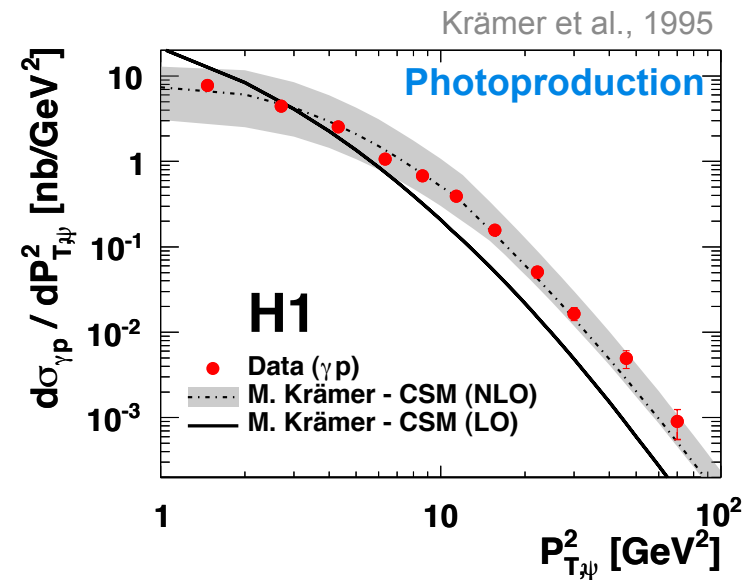

> CSM NLO calculation exists since 1995

- direct photoproduction only
- very large NLO corrections
- good description of HERA data

> Recently recalculated

- up to date set of parameters:

Krämer, 1995

- $m_c = 1.3 \text{ GeV}$
- MRST
- $\mu_r = \mu_f = \frac{1}{2} \sqrt{m_c^2 + P_{T,\psi}^2}$

Artoisenet, Maltoni, 2009

- $m_c = 1.5 \text{ GeV}$
- CTEQ6M
- $\mu_r = \mu_f = 4m_c$

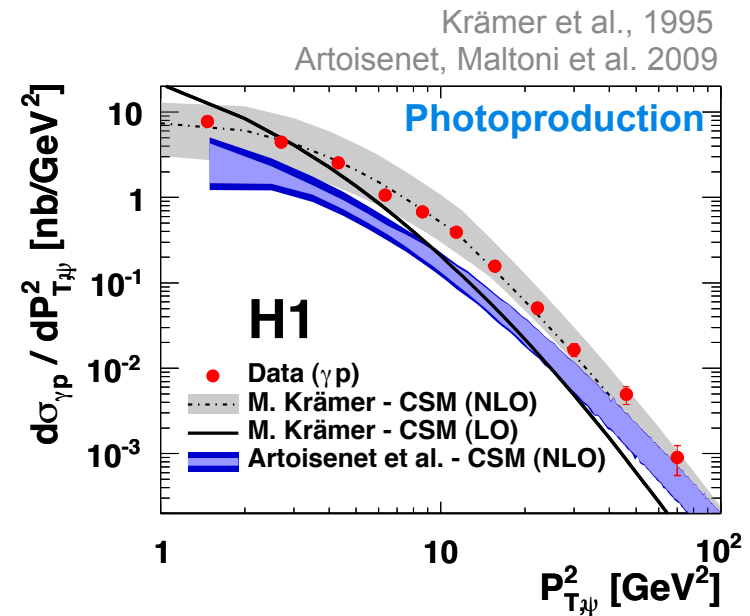

Photoproduction

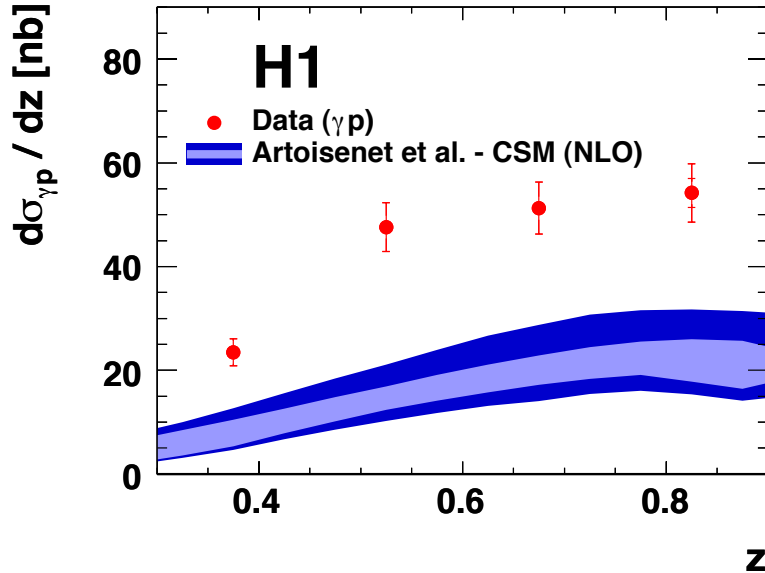

Photoproduction

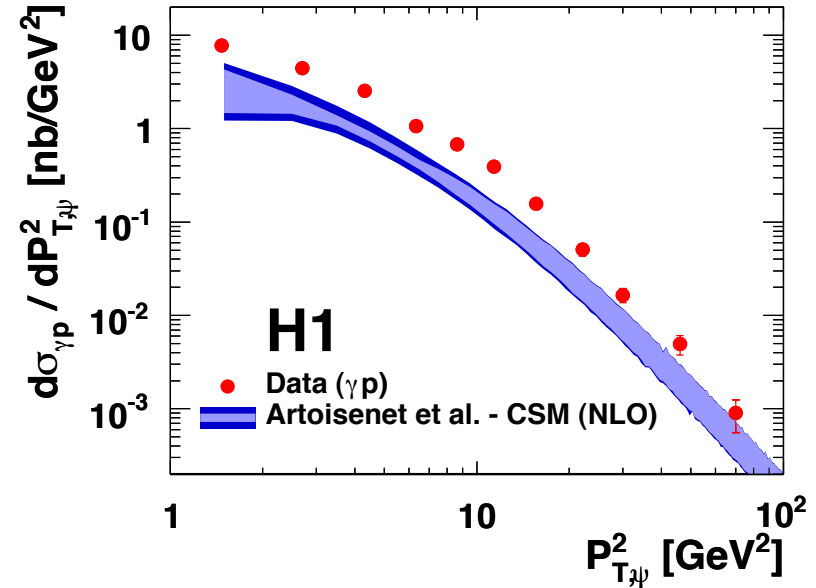

- Shapes well described by CSM NLO
- Too low in normalisation
- Huge uncertainties arising from choice of scales and parameters
- We need to recover normalisation
  - color octet contributions ?
  - N<sup>n</sup>NLO corrections ?

- HERA matrix elements calculated very recently to NLO
  - see talk by B. Kniehl (talk ID 87)
- LDME taken from Tevatron data
  - yet only available in LO
  - error band: difference between “LDME (LO)” and “LDME (LO higher order improved)”
- CO states recover normalisation
  - within huge uncertainties arising from LDME uncertainties
- Problems to describe shape as function of  $z$ 
  - LDME@NLO urgently needed

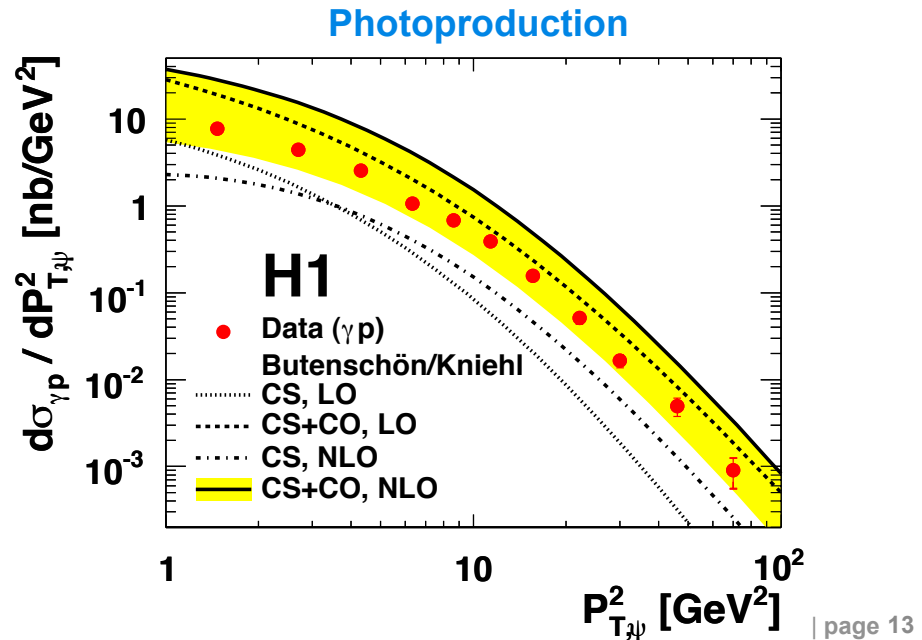
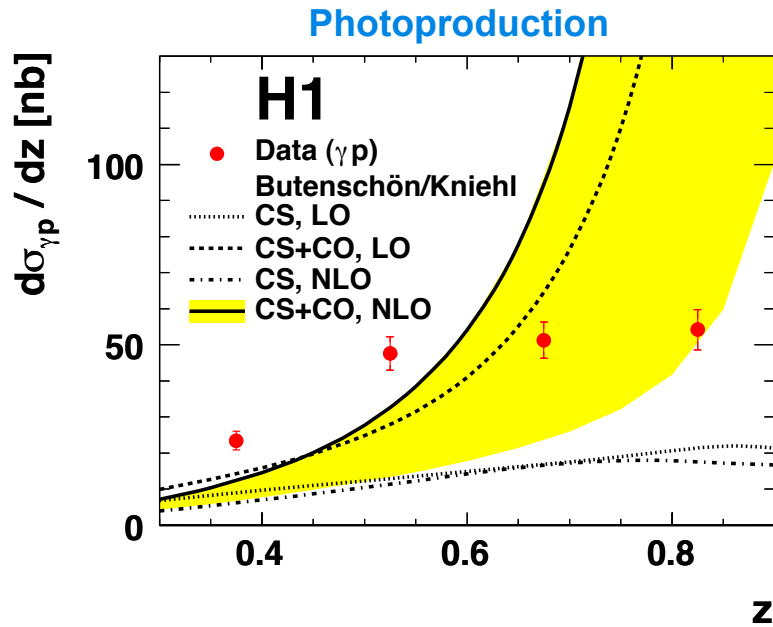

- Initial partons may be off-shell
  - contains implicitly higher order corrections
- CCFM evolution equations
  - as implemented in CASCADE
- Provides best description of the data
  - in shape and normalisation

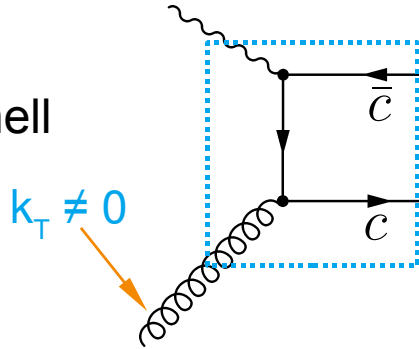

Jung, 2001

Text

## Electroproduction

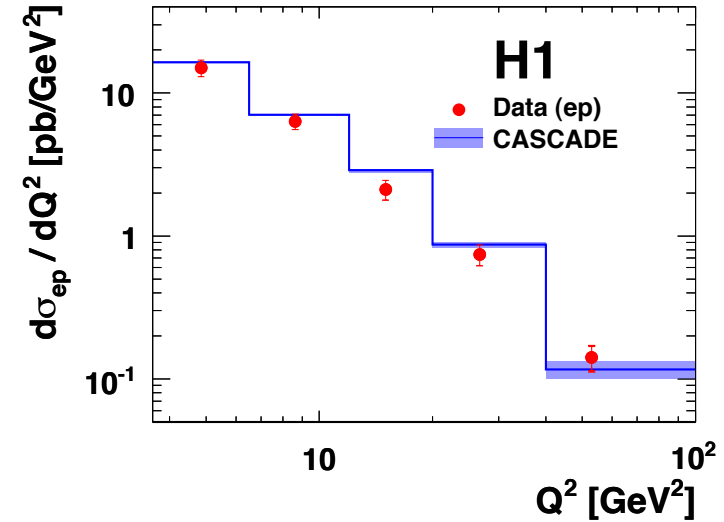

## Photoproduction

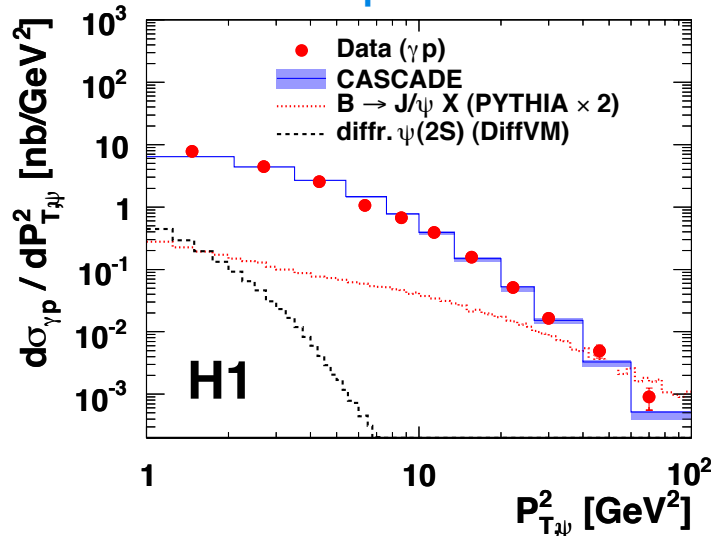

## Photoproduction

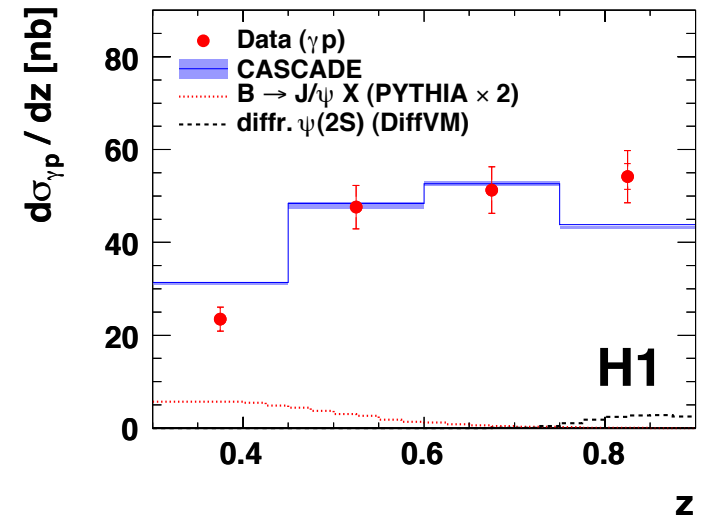



- Additional test of production models
- Polarisation parameters  $\alpha$  and  $\nu$ 
  - taken from parametrisation of angular distributions

$$\frac{1}{\sigma} \frac{d\sigma}{d\cos(\theta^*)} \propto 1 + \alpha \cos^2(\theta^*)$$

$$\frac{1}{\sigma} \frac{d\sigma}{d\phi^*} \propto 1 + \frac{\alpha}{3} + \frac{\nu}{3} \cos(2\phi^*)$$

- Two complementary frames used
  - Helicity:  $z$  axis  $\triangleq$   $J/\psi$  direction in  $\gamma p$  rest frame
  - Collins-Soper:  $z$  axis  $\triangleq$  bisector of  $\gamma$  and  $-p$  in  $J/\psi$  rest frame

- Projecting  $\mu^+$  vector onto axis yields
  - $x \sim \cos(\theta^*)$
  - $y \sim \sin(\theta^*) \sin(\phi^*)$
  - $z \sim \sin(\theta^*) \cos(\phi^*)$

- Minimise  $\chi^2$  by varying polarisation variables on generator level

J/ $\Psi$  rest frame

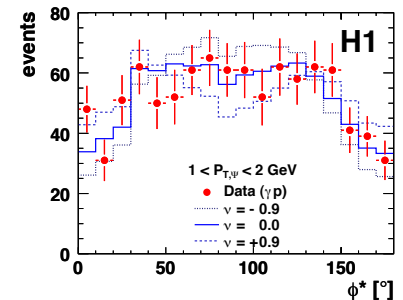
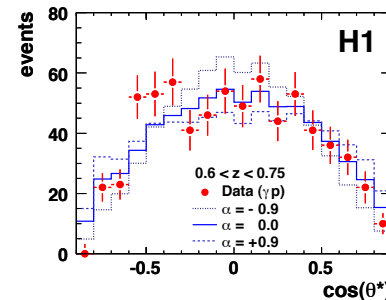
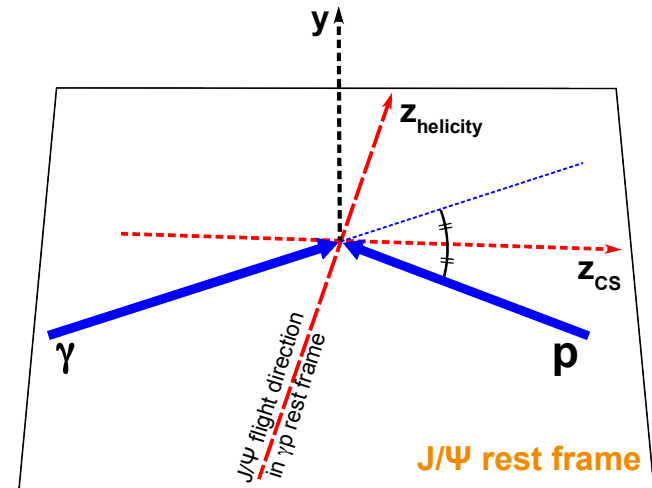
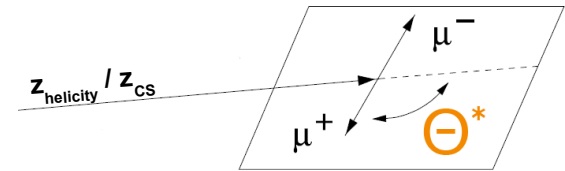

## Helicity Frame

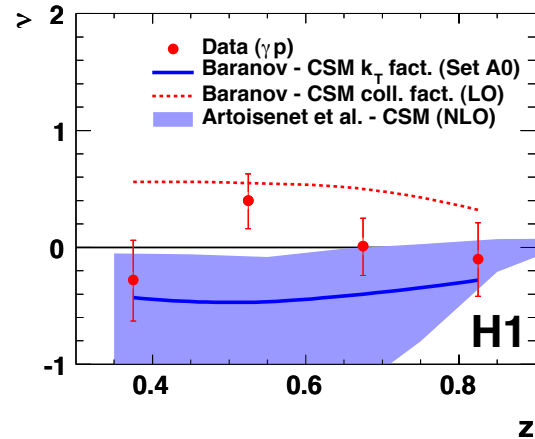
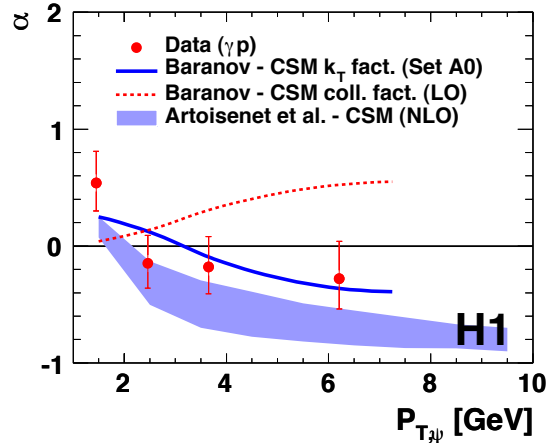

## Collins-Soper Frame

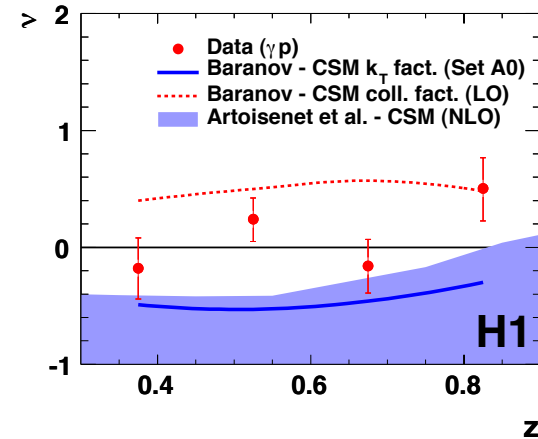
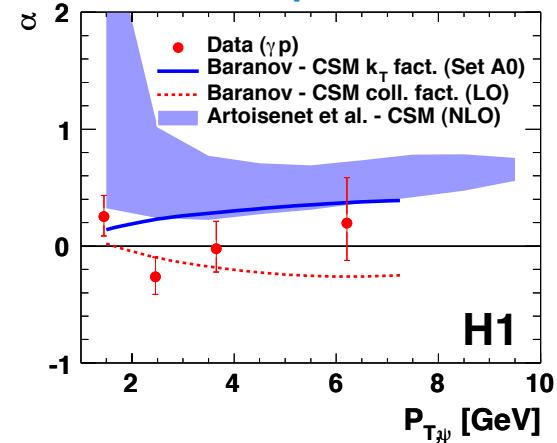

- New calculations in CSM NLO and  $k_T$  factorisation
  - Both show correct trend within large uncertainties
- Large impact of NLO corrections
  - Sign of  $\alpha$  changes

Baranov, 2009  
Artoisenet, Maltoni et al. 2009

## > Final H1 result on inelastic $J/\psi$ cross section and polarisation measurements

DESY 09-225, arXiv: 1002.0234[hep-ex] (submitted to EPJ C)

- Photoproduction and DIS using full HERA-II statistics
- Improved statistical/systematic uncertainties and detector understanding

## > Comparison to recent calculations

### ▪ $k_T$ factorisation approach (CSM)

CASCADE describes shapes and normalisation quite well

Analytical calculation models the measured polarisation parameters

### ▪ CSM NLO

'State of the art' set of parameters

Describes shape of cross sections and polarisation measurement

Too low in normalisation

Consistent with recent calculations for Tevatron

### ▪ NRQCD ('color octet model')

First calculation to NLO available for HERA

Able to recover normalisation

Problems to describe shape as function of elasticity

## > Final conclusion needs LDME@NLO and $N^n$ NLO calculations

# BACKUP

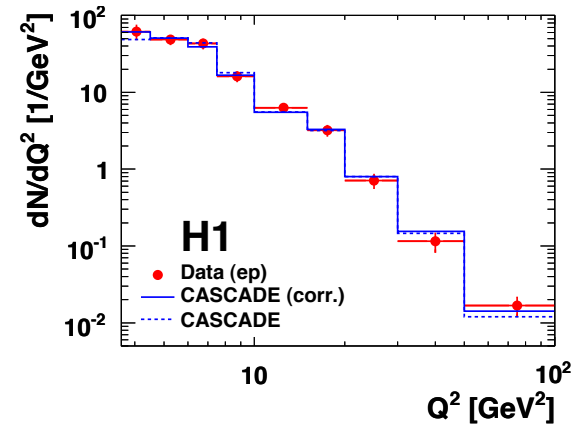
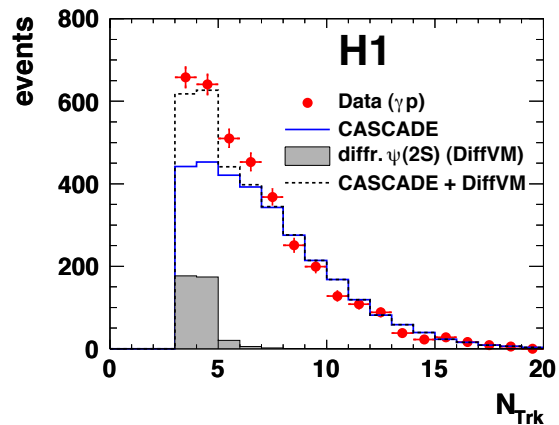
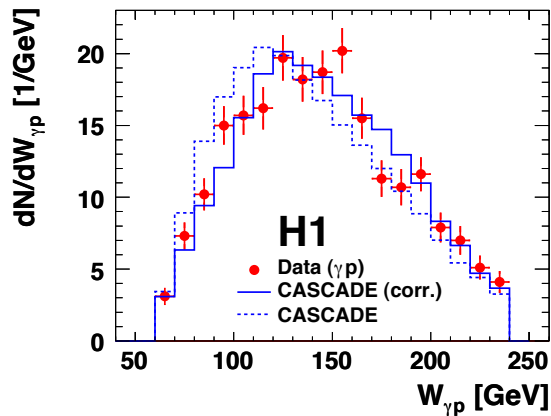
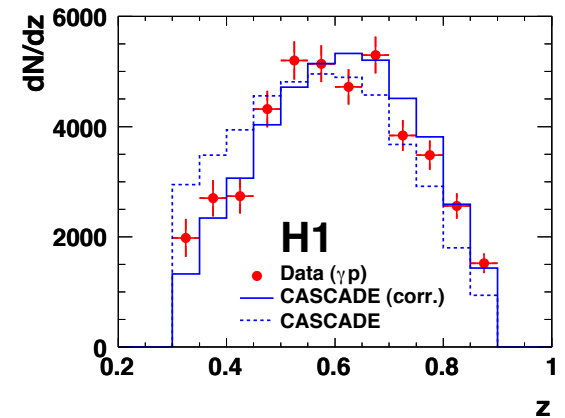
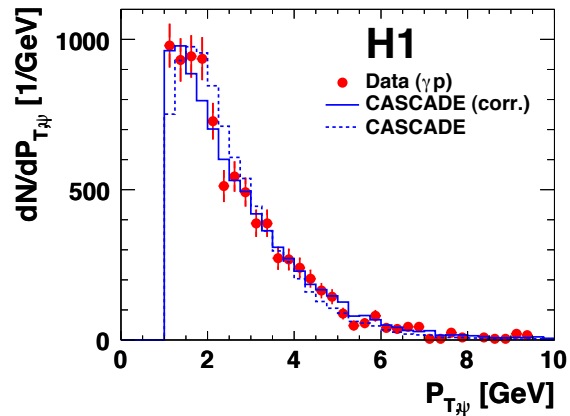
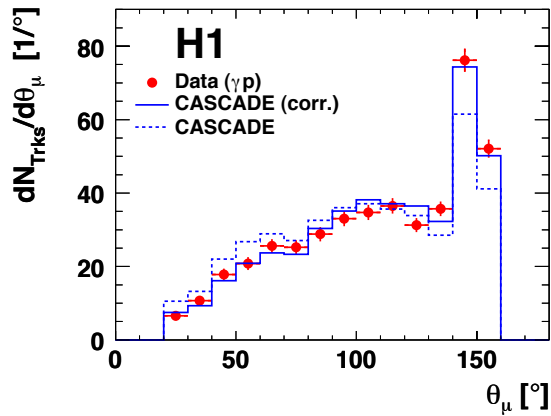

## ➤ B hadrons

- directly measures using life time tag method  
 $0.05 < z < 0.4$
- very good agreement with Pythia prediction  
 total contribution ( $0.3 < z < 0.9$ ): 3.6%  
 lowest analysed  $z$  bin ( $0.3 < z < 0.45$ ): 20.0%

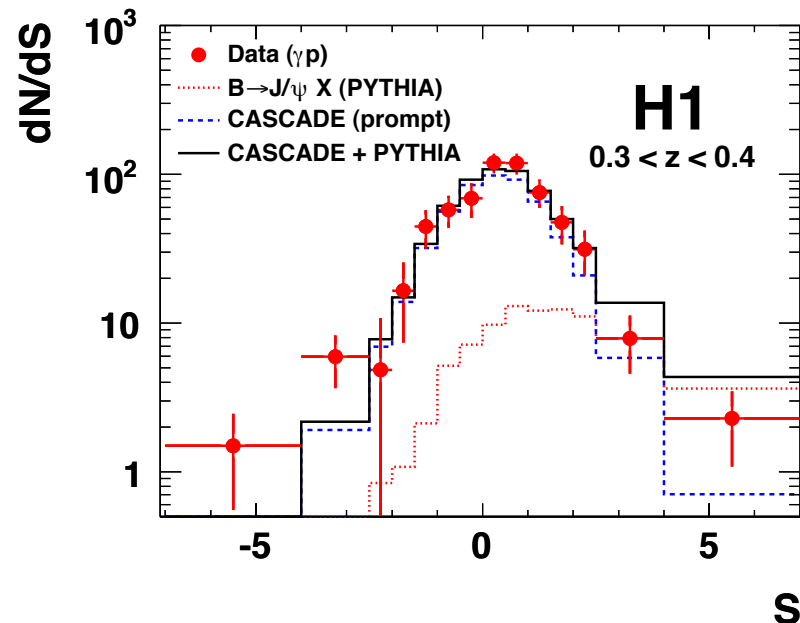
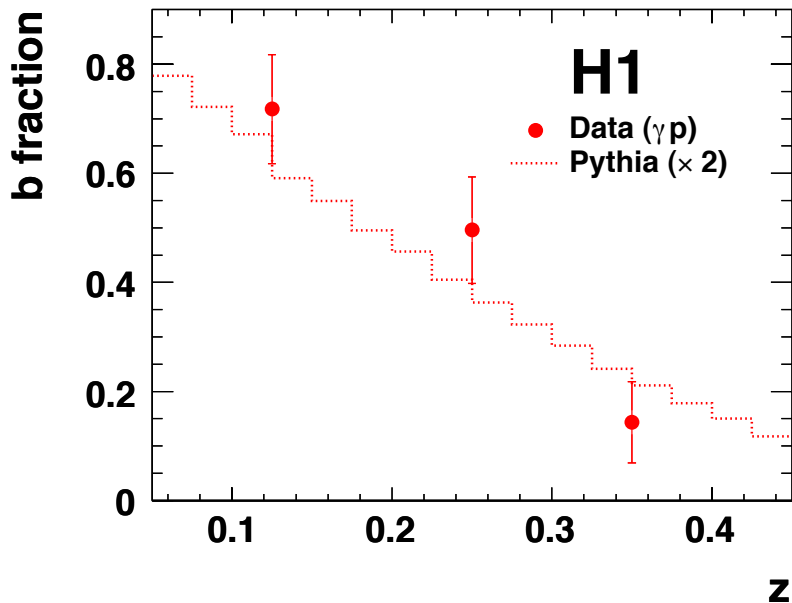



- new calculation consistent with Tevatron results
  - shape described, lower in normalisation
  - CSM NLO produced by same authors
  - NNLO contribution still large

