

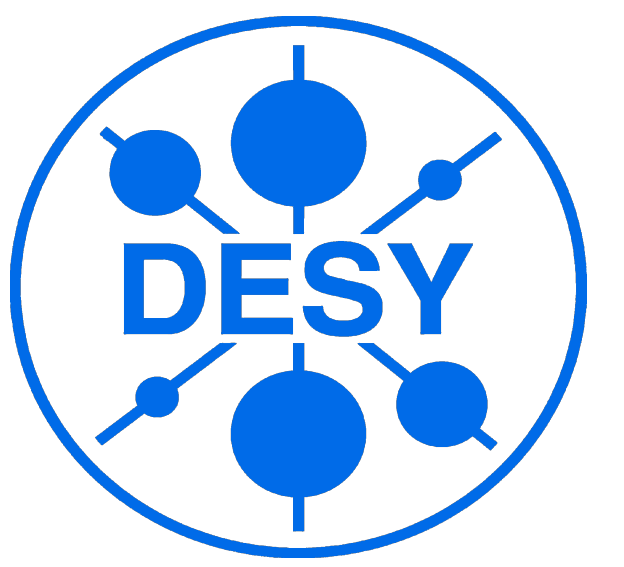

H1 Collaboration

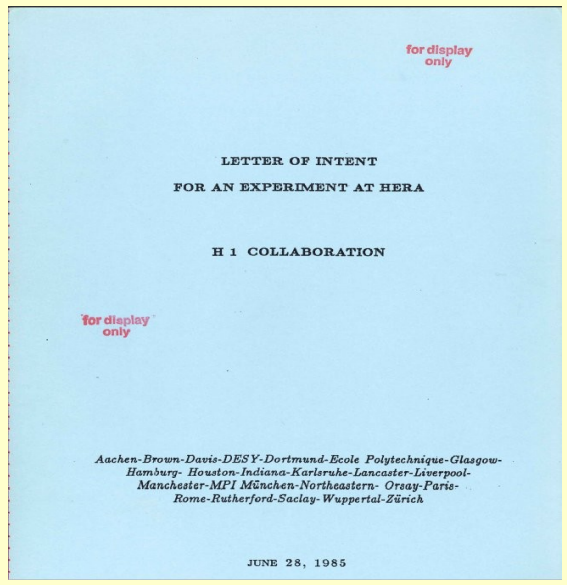

From 1985 till today: 1196 physicists from 49 institutes and 19 countries



Letter of Intent, 1985

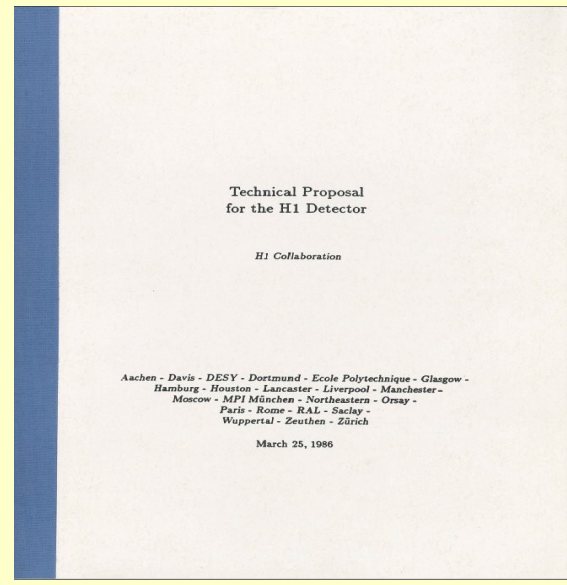

Techn. Proposal, 1986



The First Collaboration meeting: DESY 1986



H1 Collaboration in the HERA North Hall, 1994



Recent Collaboration meeting: Cracow 2011

Building the H1 Detector, 1986 – 1992

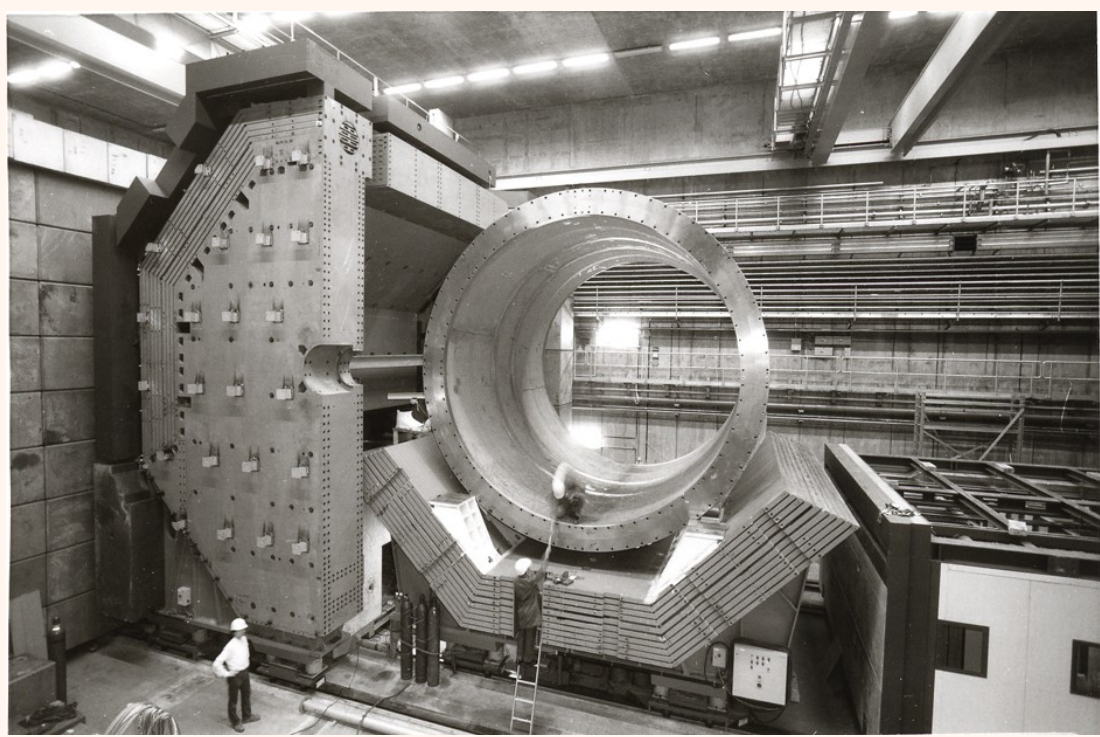
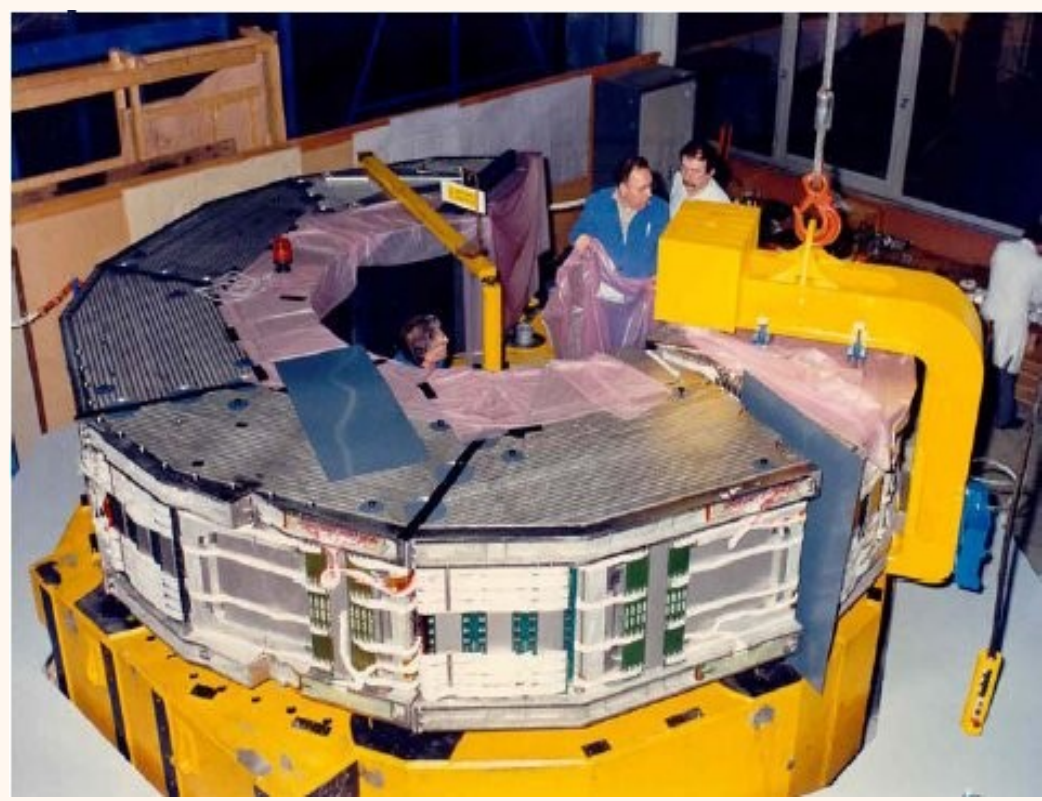

The H1 Detector

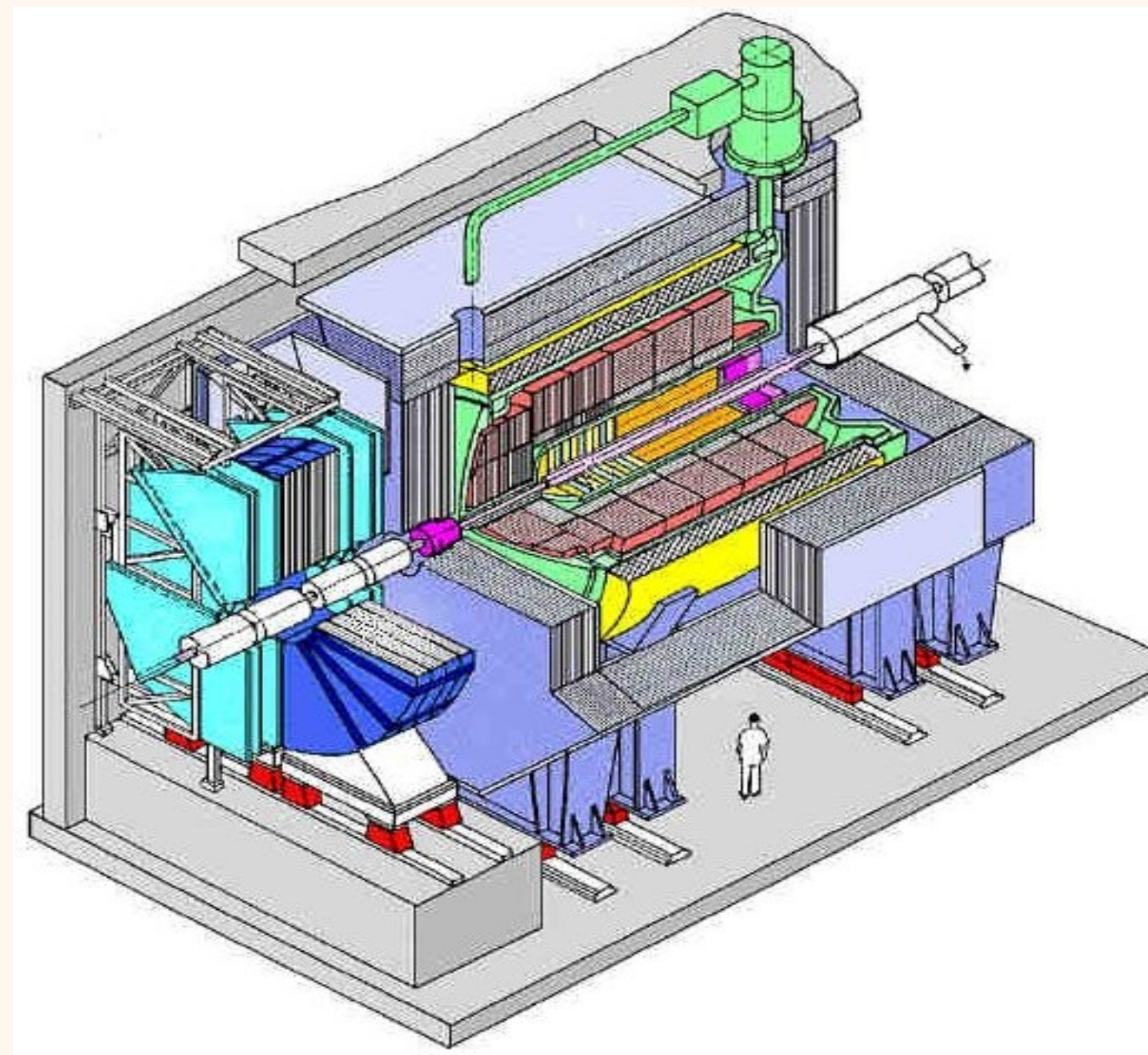

First Lumi, 1991

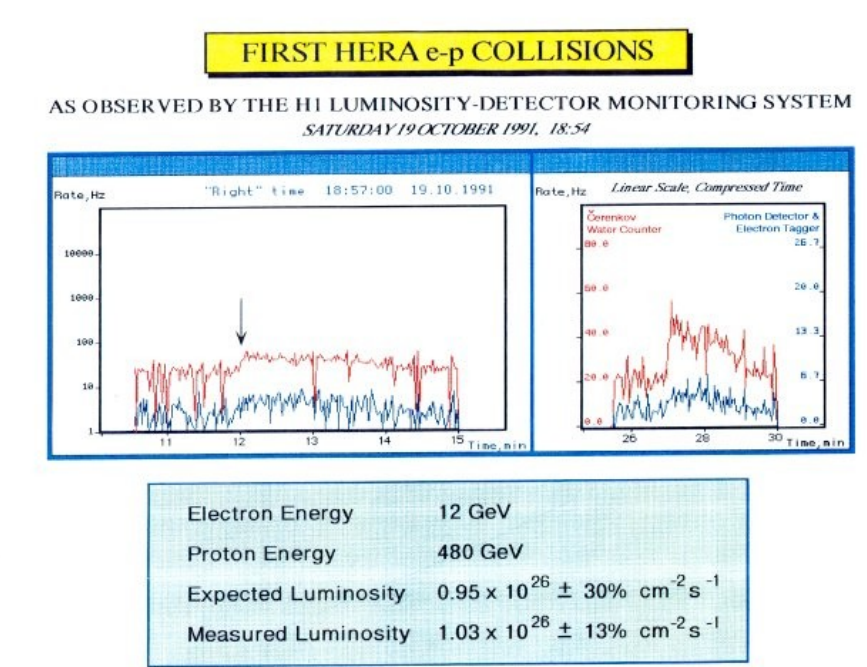

First ep Event, 1992

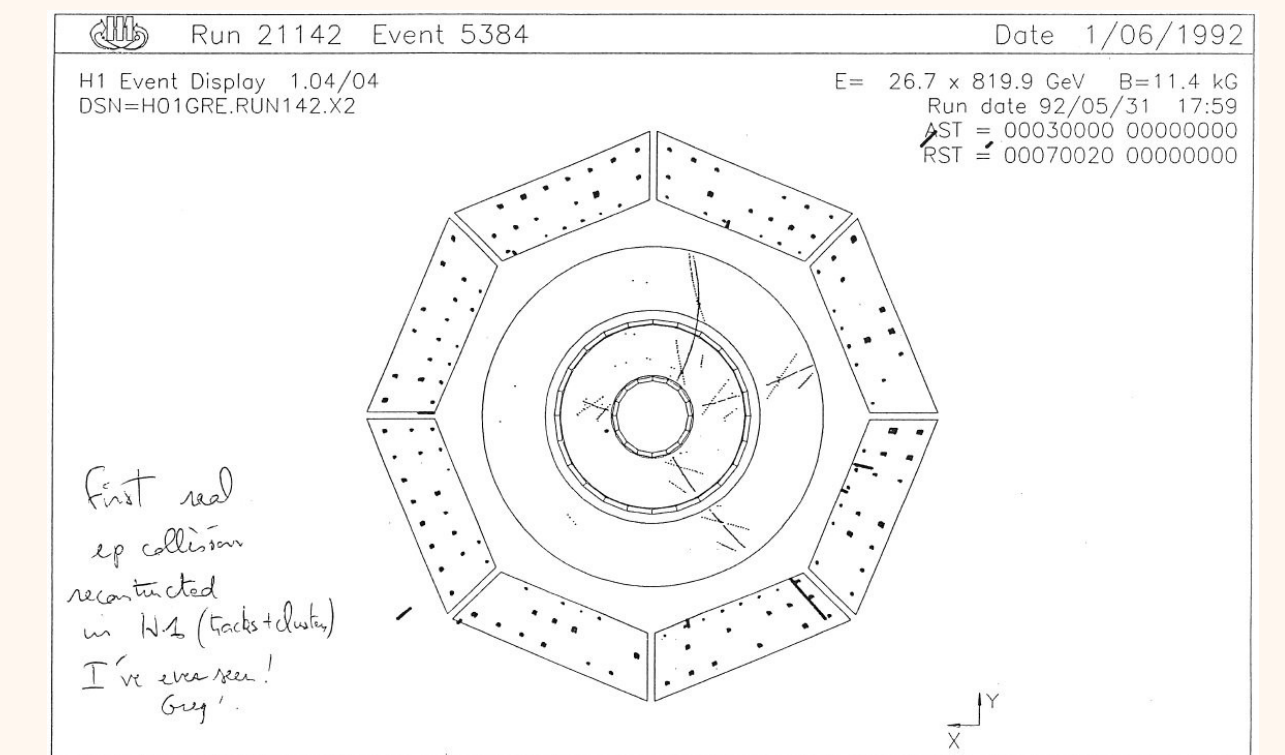

Prominent Events and first Results

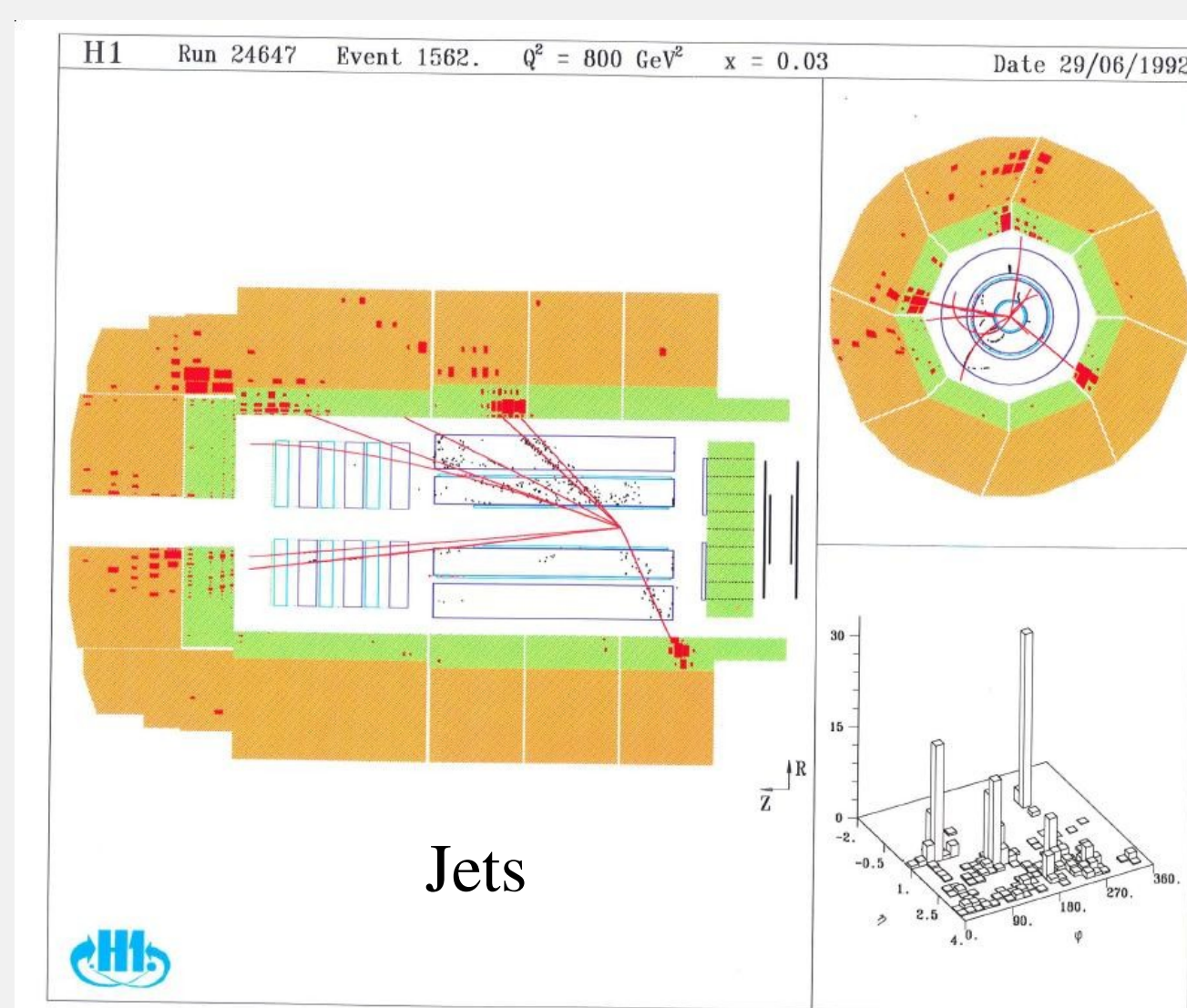
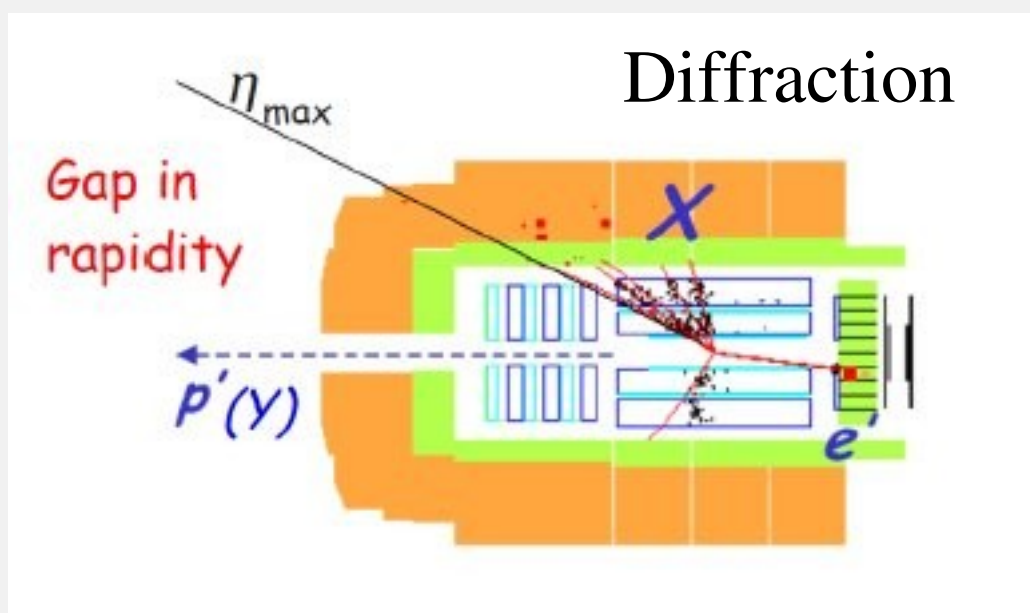
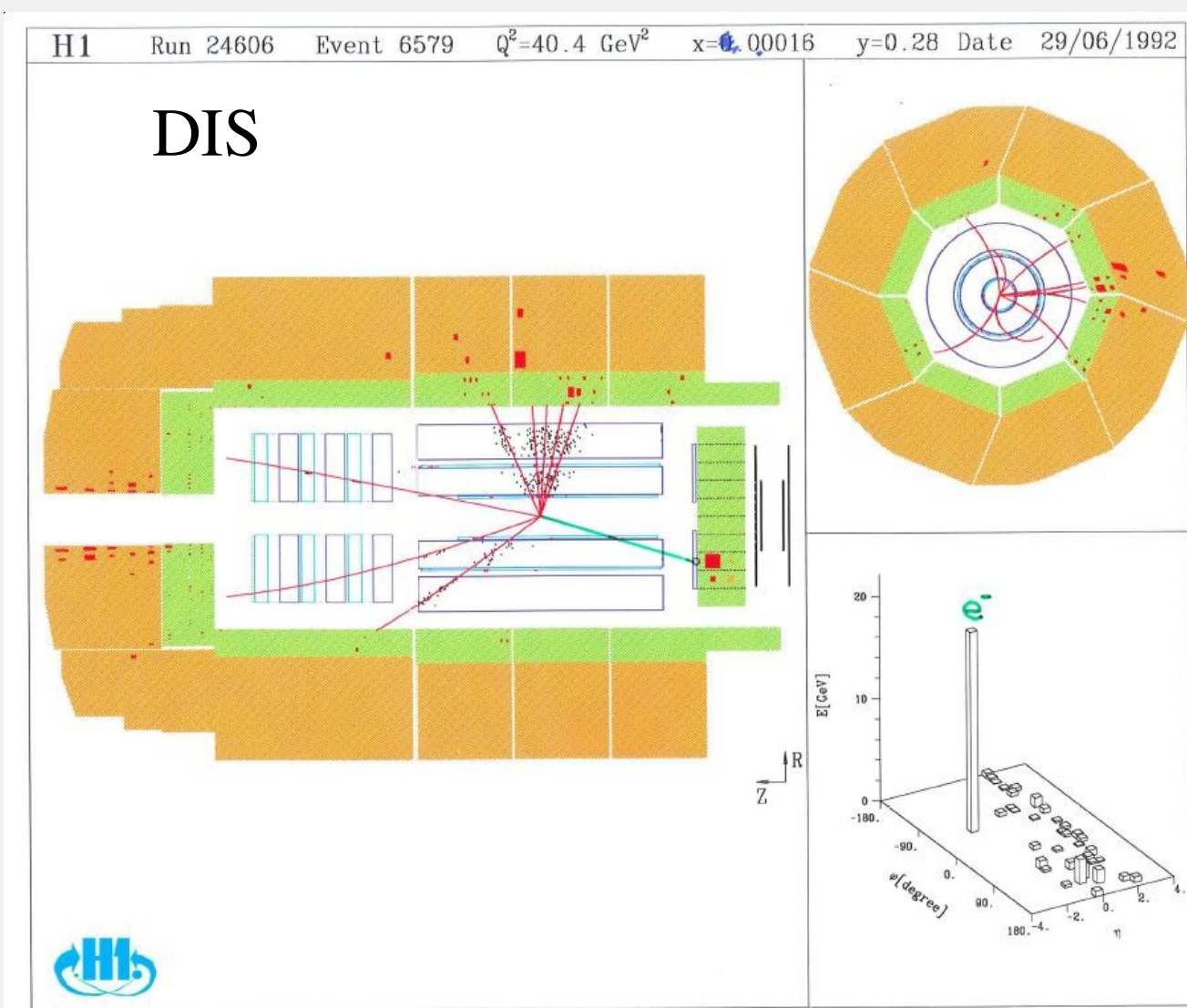

Total Photoproduction Cross Section

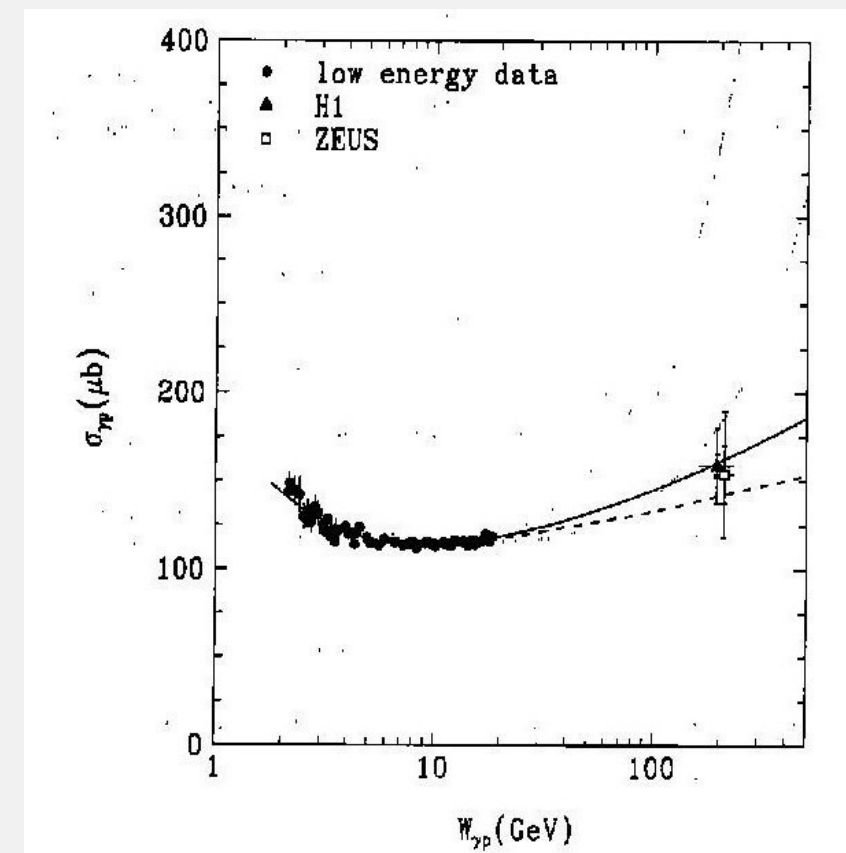

First results on the total photoproduction Cross Section measurement with the H1 detector at HERA. The data were extracted from low Q² collisions of 26.7 GeV electrons with 820 GeV protons.

First F₂

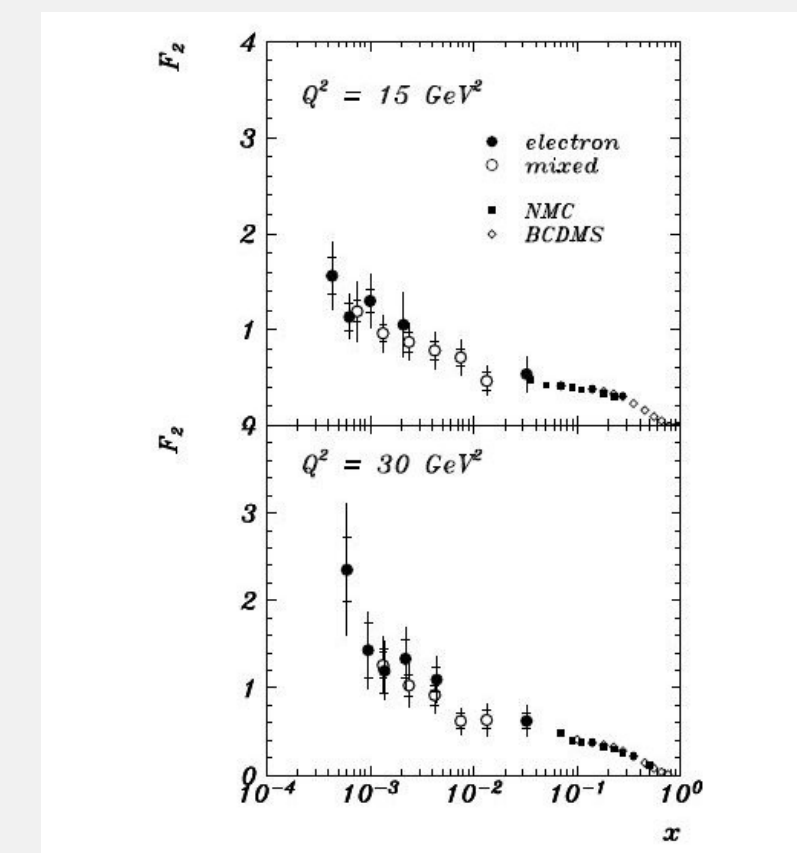

First measurement of F₂ by H1: the Structure Function indeed rises strongly at low x

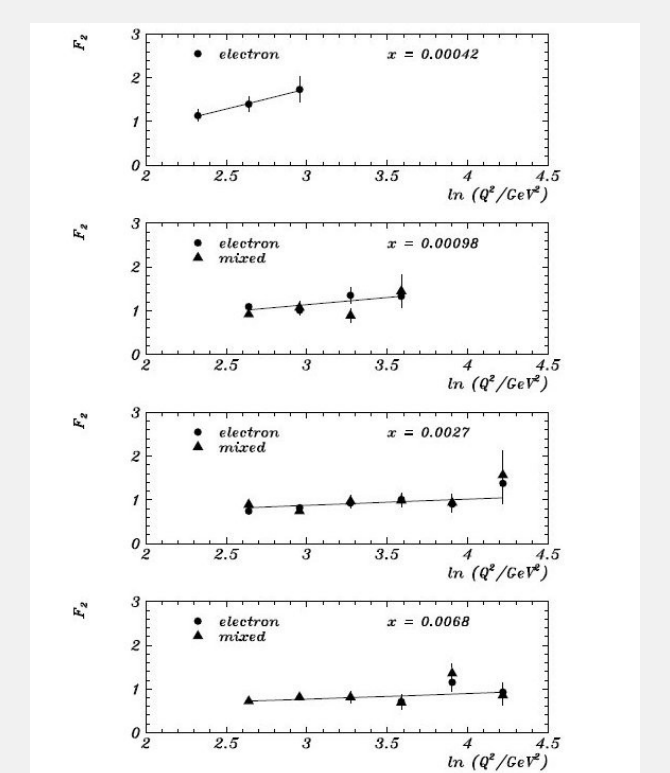

First gluon distribution from scaling violations

spokespersons ...

and technical coordinators

The Achievements of the H1 experiment

The measurements:

- Have reached a precision beyond all expectations, and are ahead of theory in terms of systematic errors.
- Highlight QCD as the theory of the Strong Interactions, confirm all theory predictions in ever finer detail.
- Explore and map out the structure of the Proton, the Photon and the Pomeron, provide important input to the LHC measurements and future discoveries.

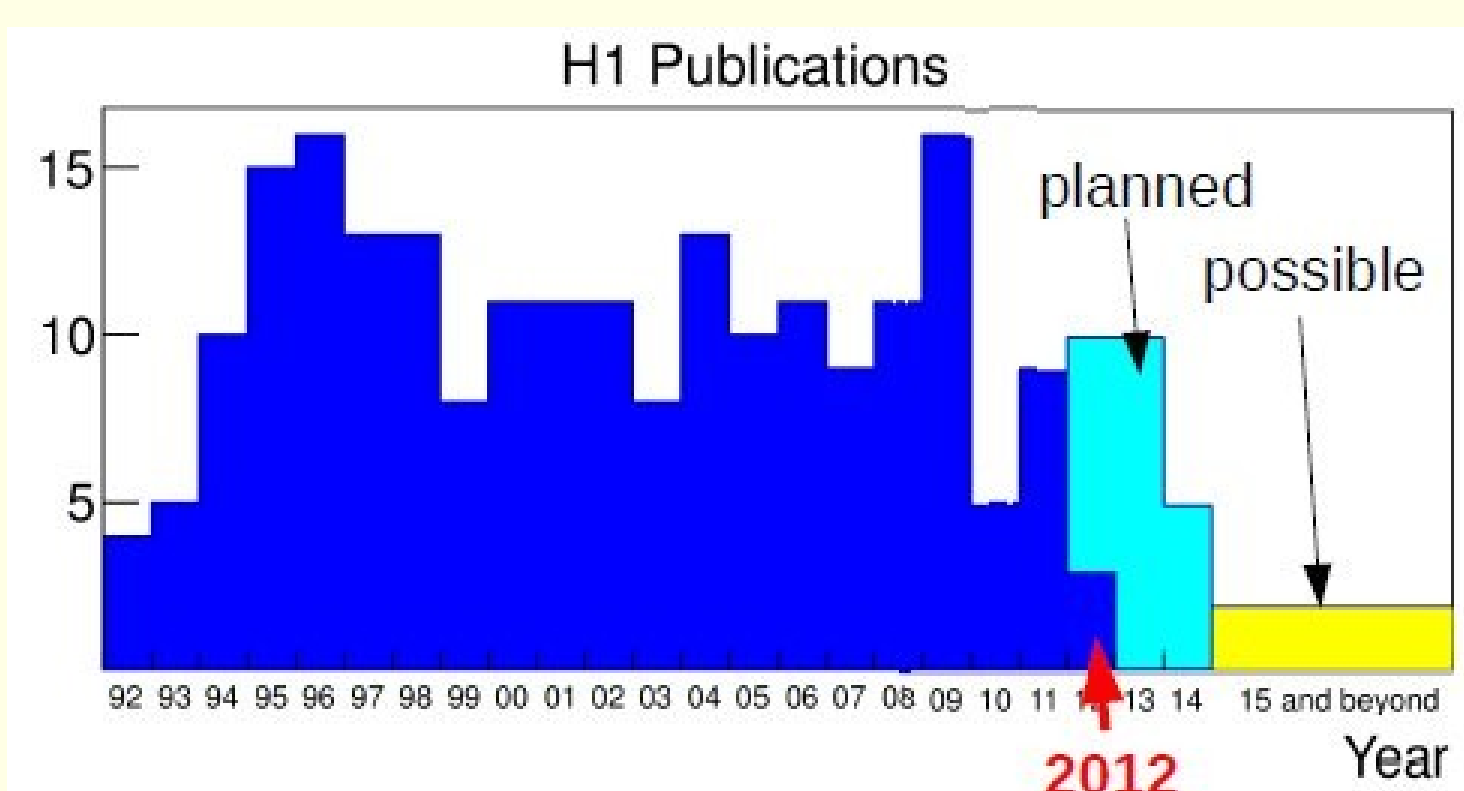

883 PhD and Diploma Theses Statistics 1986 - 2012

Citation summary results	All papers	Published only
Total number of citable papers analyzed:	218	218
Total number of citations:	14,538	14,534
Average citations per paper:	66.7	67.6
Breakdown of papers by citations:		
Renowned papers (500+)	1	1
Famous papers (250-499)	9	9
Very well-known papers (100-249)	32	32
Well-known papers (50-99)	42	42
Known papers (10-49)	110	110
Less known papers (1-9)	18	17
Unknown papers (0)	6	4

First renowned H1 paper: "Deep inelastic inclusive ep scattering at low x and a determination of α_s"

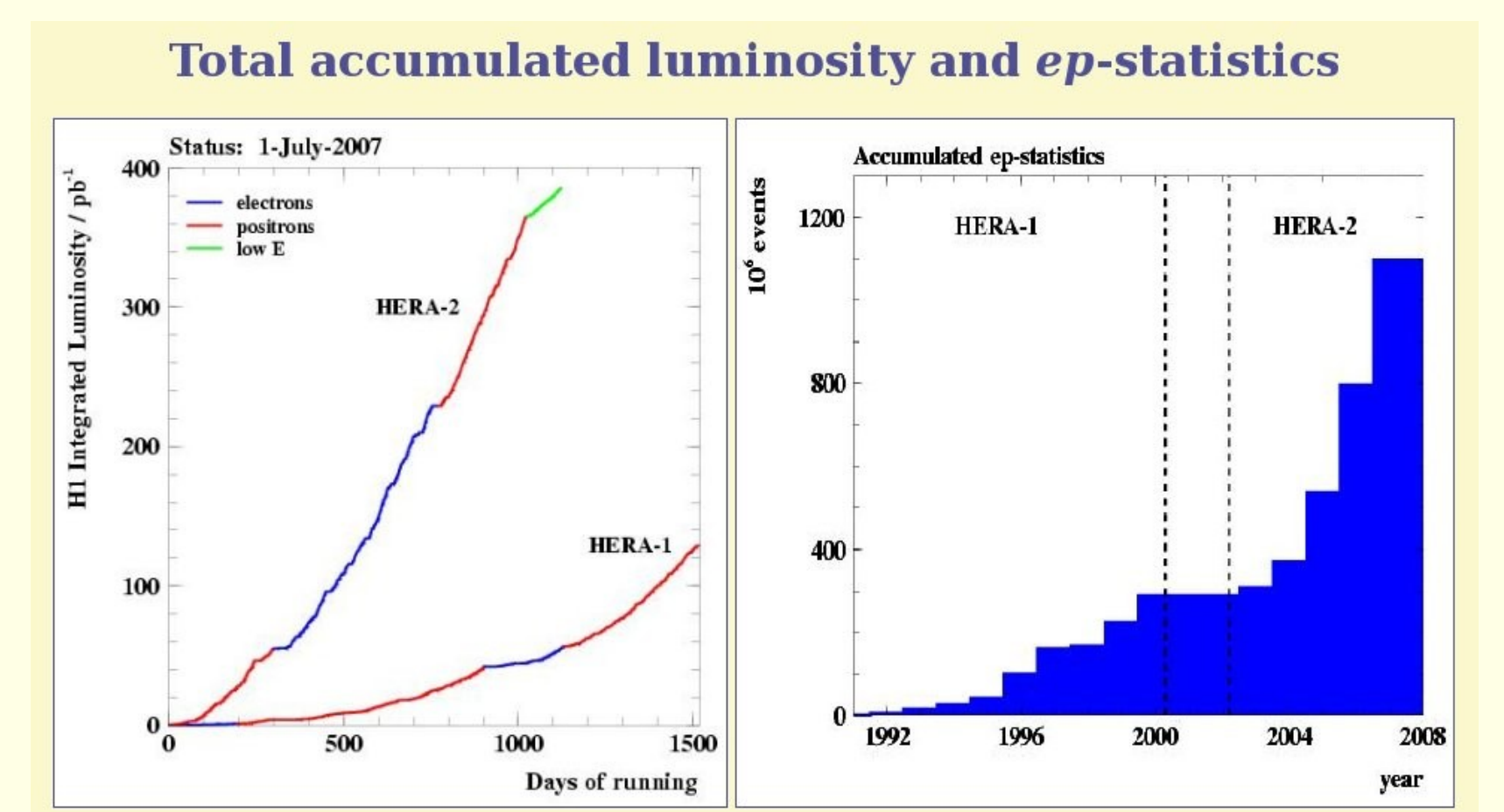

The data are a rich and unique source of information, and continue to provide new physics results