

On behalf of the H1 Collaboration

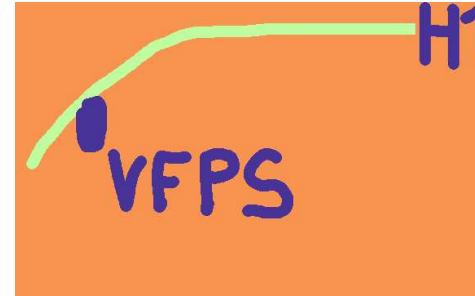

Status of the H1 Very Forward Proton Spectrometer

XIIth International Workshop on Deep Inelastic Scattering

Strbske Pleso, Slovakia, April 14rd - 18th, 2004

Diffraction at HERA

At HERA, 10% of low- x DIS events are diffractive

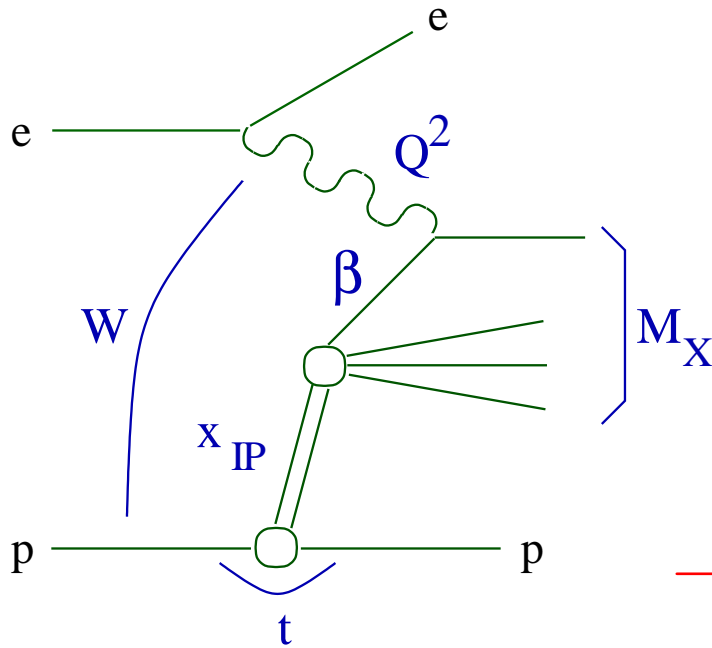

Q^2 , x (or W), M_X (or M_{VM})

x_{IP} : momentum fraction of colour singlet exchange

β : fraction of exchange momentum of struck q

$$x = x_{IP} \beta$$

t : 4-momentum transfer squared

→ Probe QCD structure of colour singlet

HERA I: Measurements of F_2^D , jets, charm, Vector Mesons, DVCS,...

BUT Statistically (exclusive channels) or
Systematically (proton dissociation) limited

HERA II:

- High luminosity, e polarisation
- New forward proton spectrometer in H1
- + t -dependence

HERA I: Forward Proton Spectrometer

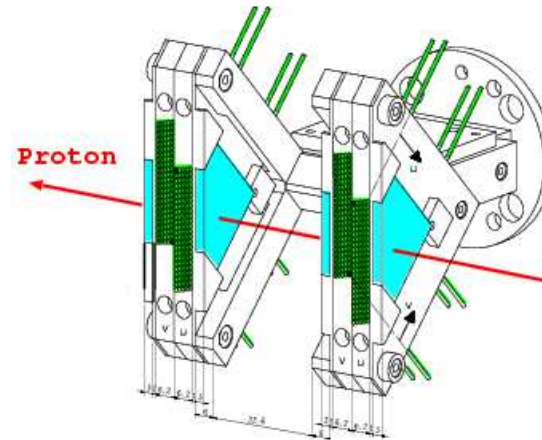
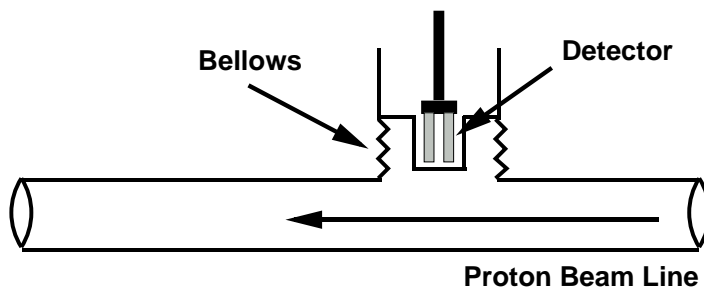
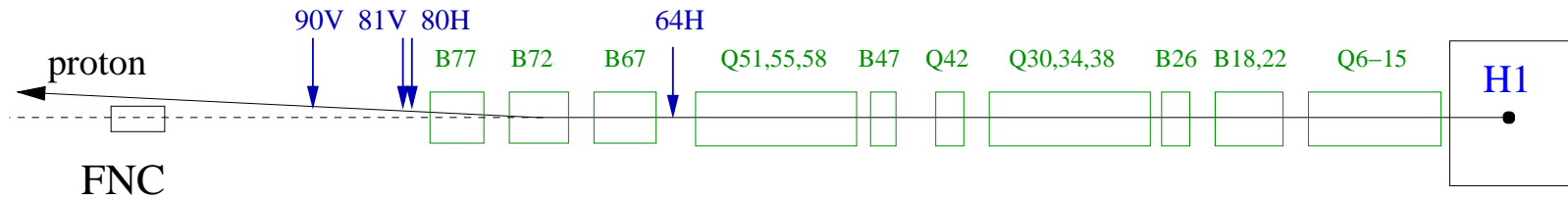

- Scintillating fibre detector
- Free of proton dissociation bkgd
- proton 4-momentum measurement $\rightarrow t$
- Small acceptance

HERA I Results: $F_2^{D(3)}$

$$\frac{d^4\sigma_{ep \rightarrow eXp}}{dQ^2 dx_{IP} dt d\beta} = \frac{4\pi\alpha_{em}^2}{\beta Q^4} \left(1 - y + \frac{y^2}{2}\right) F_2^{D(4)}(Q^2, x_{IP}, t, \beta)$$

Horizontal FPS Stations:

- Few % acceptance at high $|t|$ and low x_{IP}
- 99/00 data : 28.8 pb^{-1}

Vertical FPS Stations:

- Large acceptance at low $|t|$ and high x_{IP}
- 1995 data : 1.4 pb^{-1}

BUT statistically limited

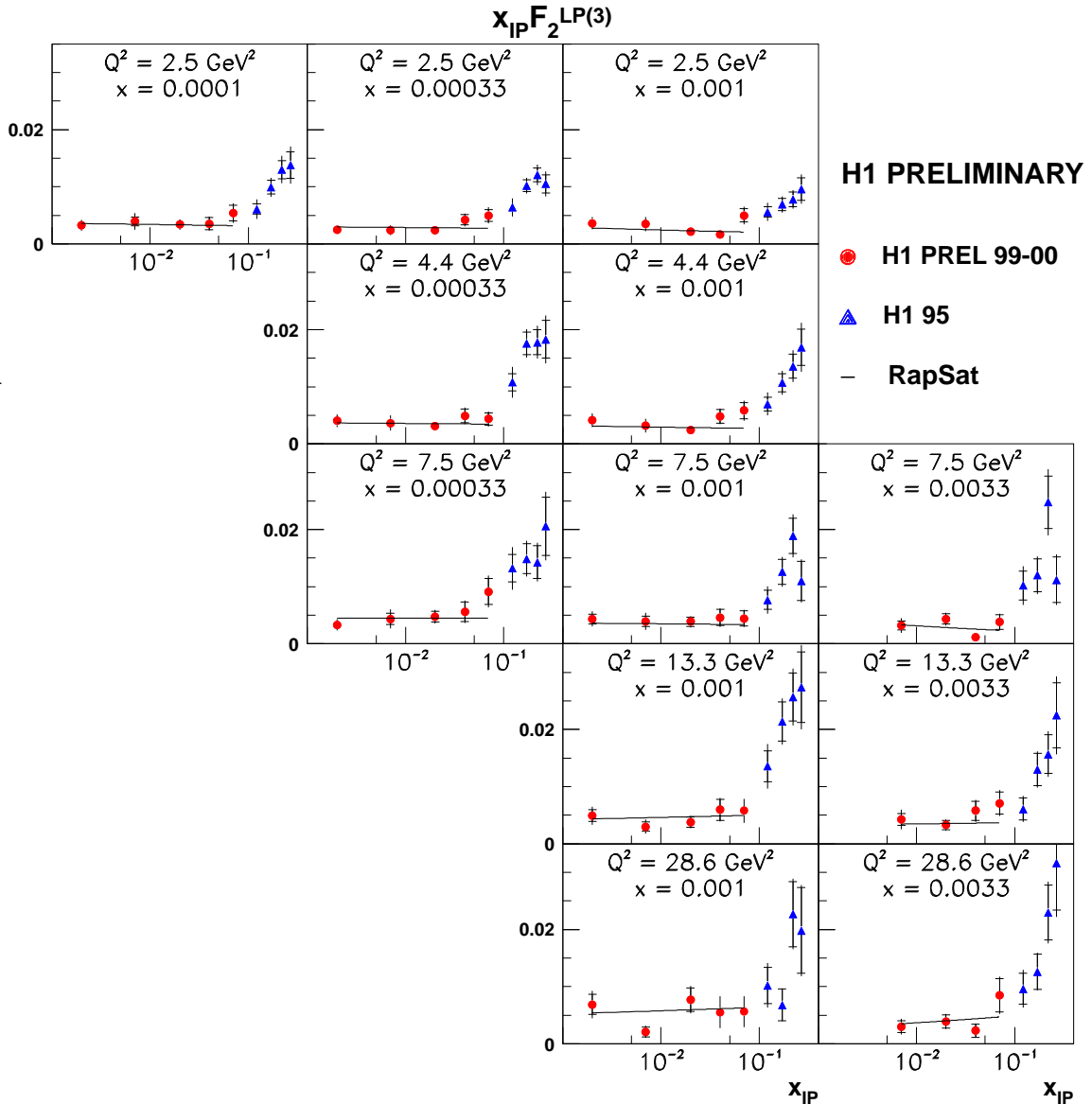

HERA I Results: ϕ Measurement

$\frac{d\sigma^D}{d\phi}$ sensitive to σ_L^D through interference term :

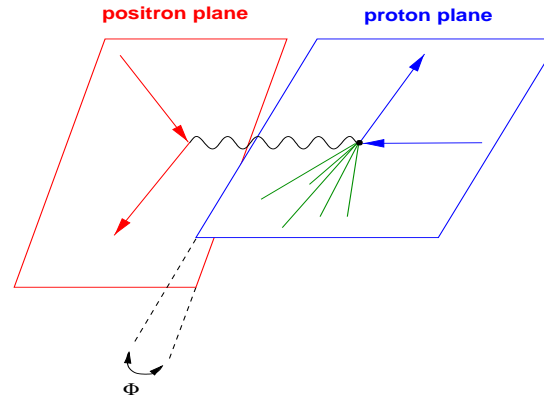

$$\frac{d\sigma^D}{d\phi} \propto \sigma_T + \sigma_L - 2\sqrt{\epsilon(1+\epsilon)}\sigma_{LT} \cos \phi - \sigma_{TT} \cos 2\phi$$

Fit asymmetries :

$$\frac{d\sigma^D}{d\phi} \propto 1 + A_{LT} \cos \phi$$

→ Asymmetries small

BUT high β not covered

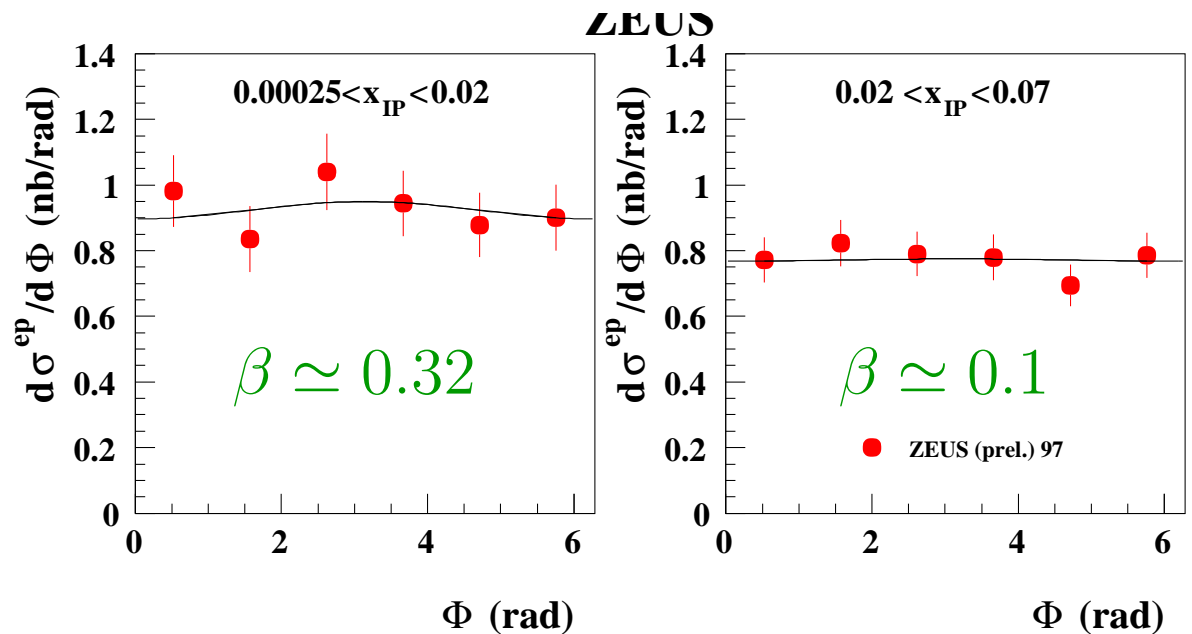

$$A_{LT} = -0.029 \pm 0.066^{+0.026}_{-0.047} = -0.005 \pm 0.052^{+0.048}_{-0.047}$$

The H1 Very Forward Proton Spectrometer

Tag and measure the scattered proton at HERA II with large acceptance at low $x_{\mathbb{P}}$ and down to lowest t

⇒ Precision studies of $ep \rightarrow epX$

HERA II beam optic simulation :

⇒ Best location is 220 m in the horizontal plane (Use HERA bend)

⇒ Down to $t = 0 \text{ GeV}^2$ for $x_{\mathbb{P}} \sim 10^{-2}$

BUT Cold Magnet Section

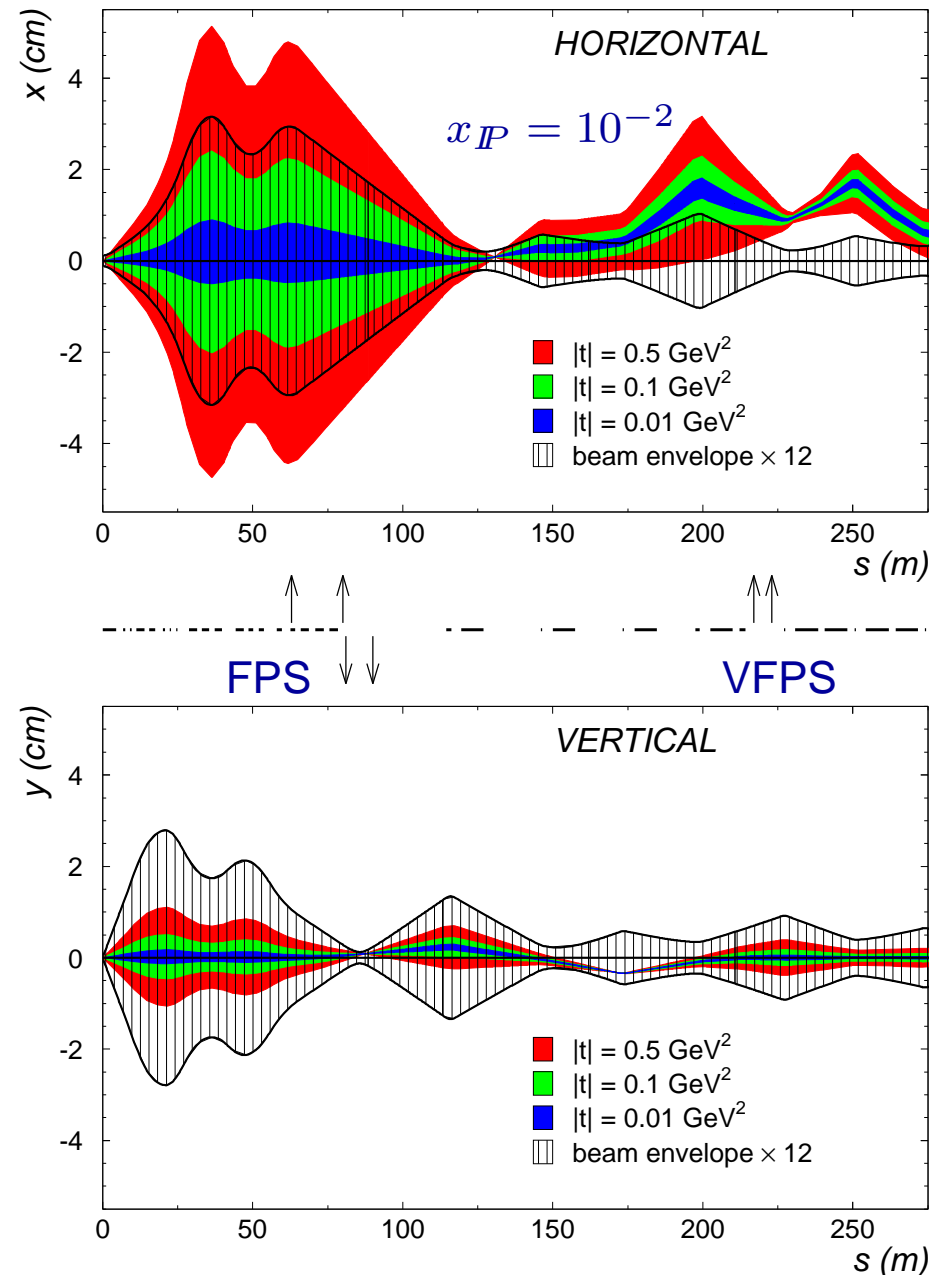

Cold Beam Line Bypass

Horizontal Bypass for helium and superconducting lines

⇒ Access to proton beam tube for 10 m

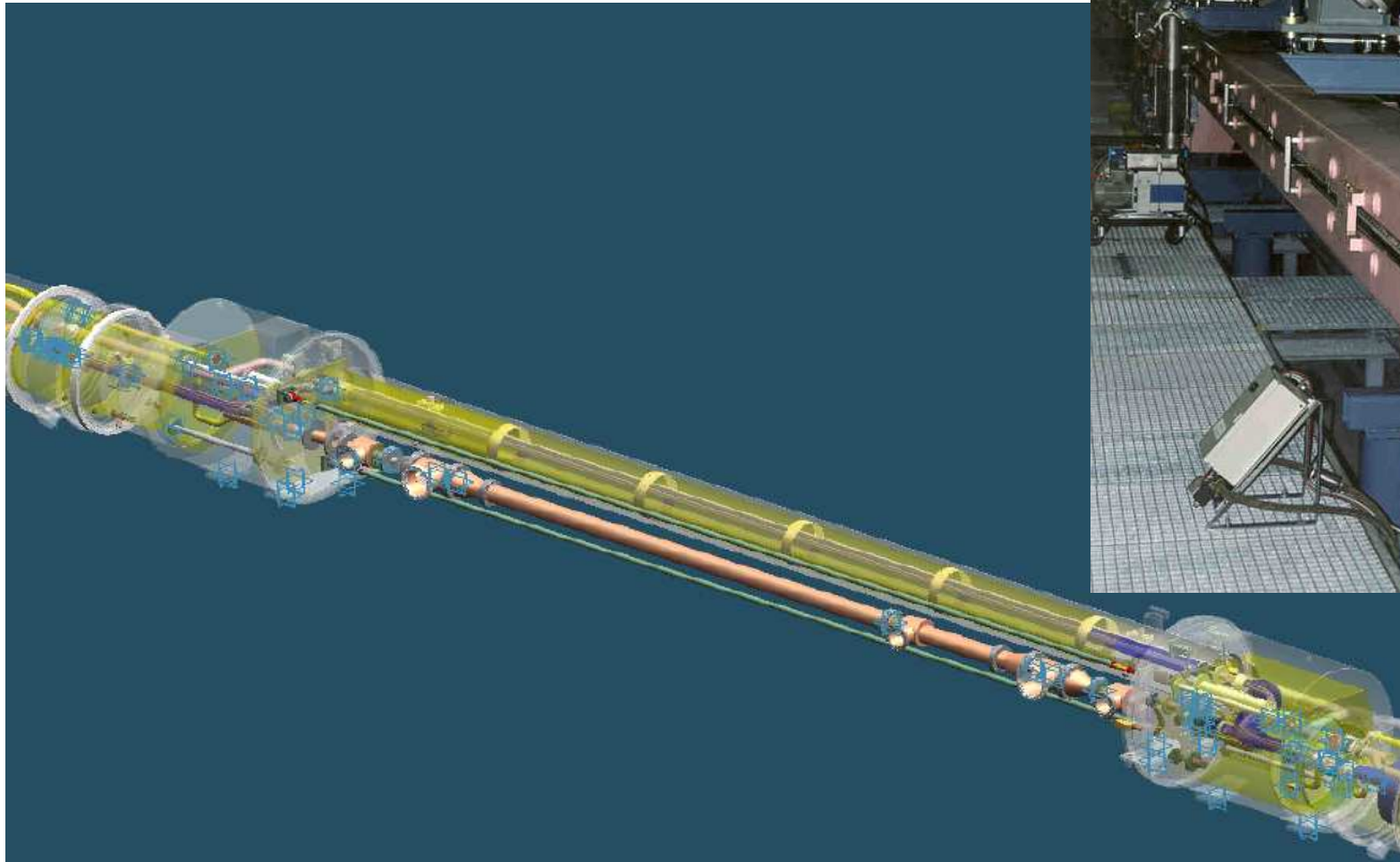

VFPS Detectors

Detectors :

- Same design as Vertical FPS
- 2 detectors: 218 m and 222 m
- 4 Trigger Tiles / plane, 4 planes
- Fibers for spatial reconstruction
→ Resolution = 100μ

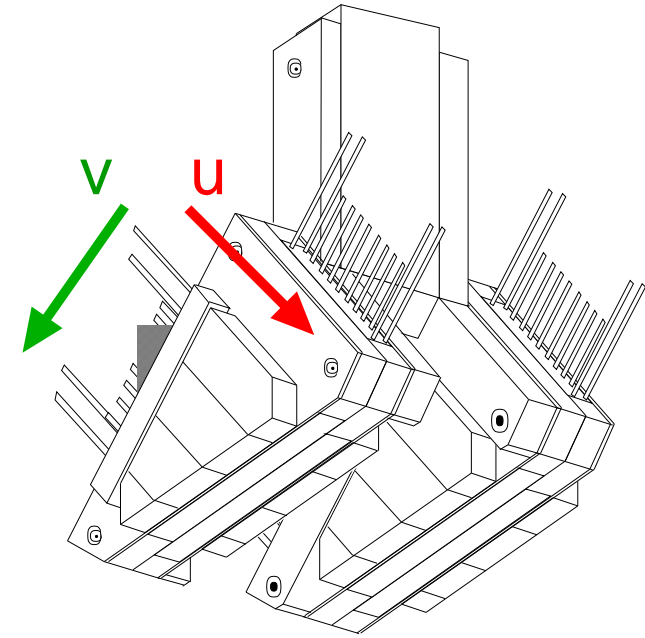

Optical Connection :

- Tiles : PM , Fibres : PSPM
- 5 fibers layers (= 1 plane) → 1 light guide
- 4 light guides → 1 PSPM pixel (**multiplexing**)

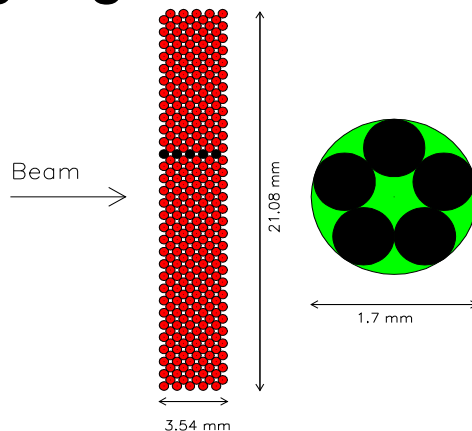

Mask

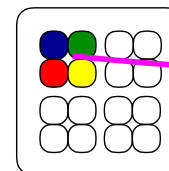

PSPM

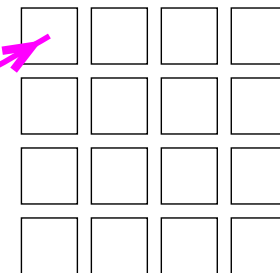

VFPS Acceptance

Acceptance defined by beam optics and envelope (12σ detector approach limit)

VFPS

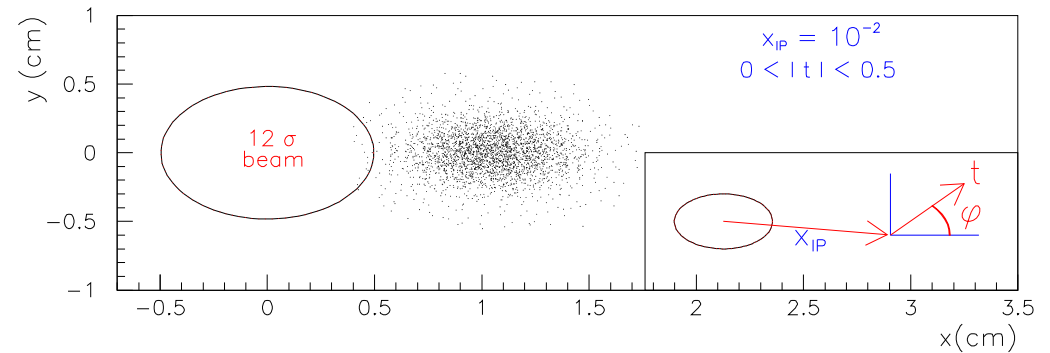
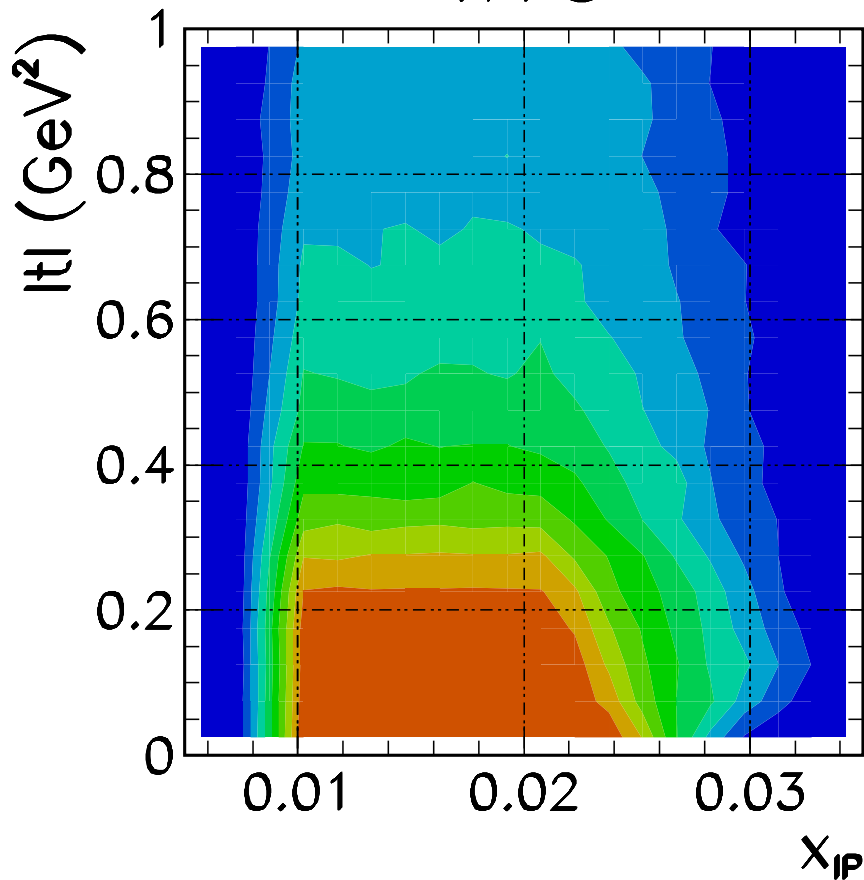

Complementary to FPS (High x_{IP})

FPS + VFPS

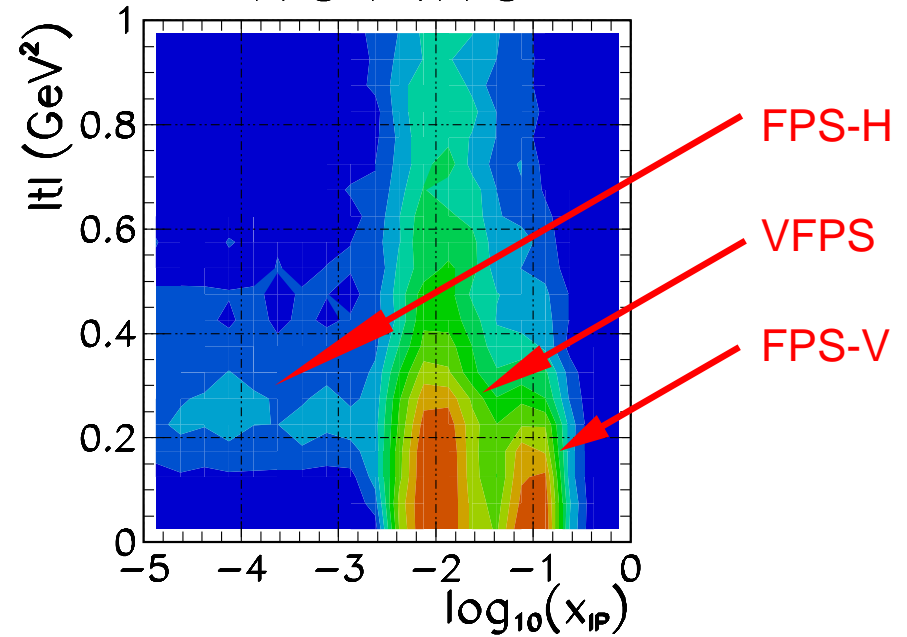

$\Rightarrow \sim 100\%$ acceptance for $|t| \lesssim 0.2 \text{ GeV}^2$ and $0.01 \lesssim x_{IP} \lesssim 0.02$

VFPS Resolution

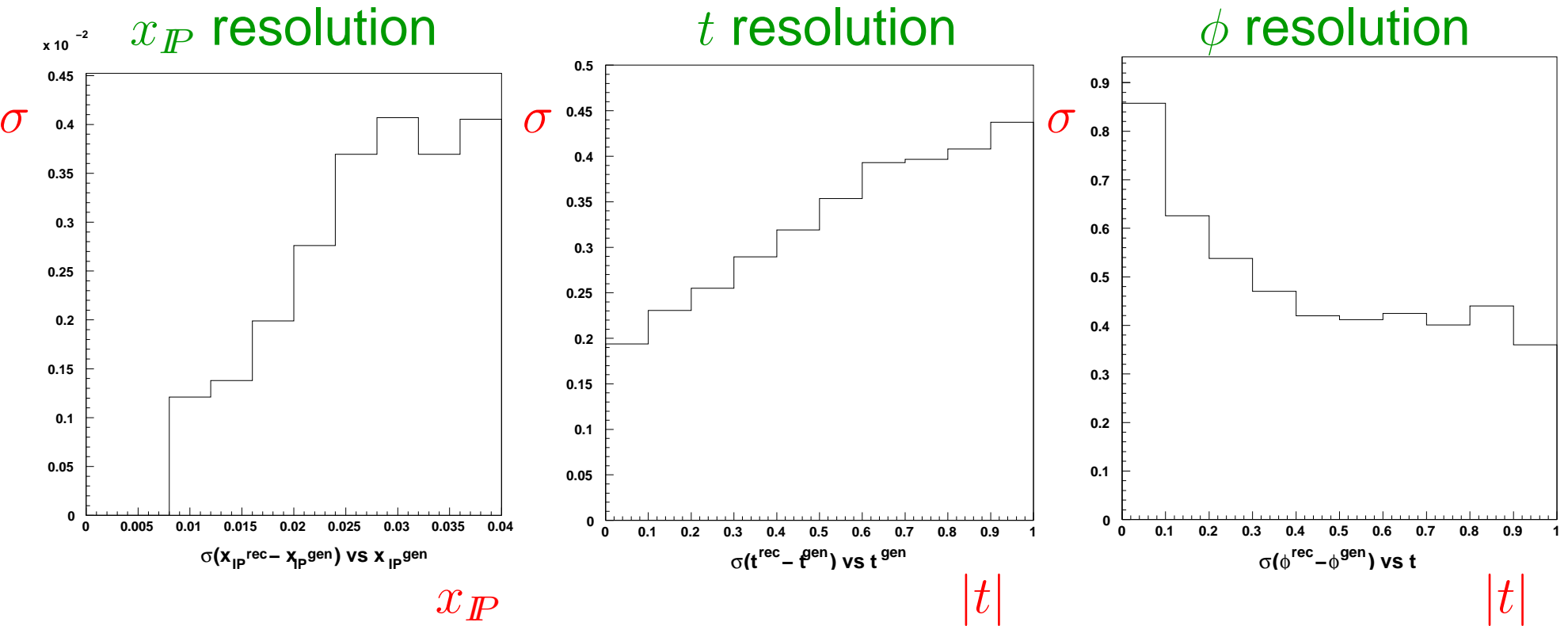

- Resolution dominated by beam characteristics
- x_{IP} resolution competitive with central H1 x_{IP} reconstruction
- ~ 4 bins in $|t|$ for $|t| < 0.4 \text{ GeV}^2$
- ~ 15 bins in ϕ for $|t| > 0.2 \text{ GeV}^2$

VFPS Installation

Done during the summer 2003 HERA shutdown

→ First tests and commissioning started in january 2004

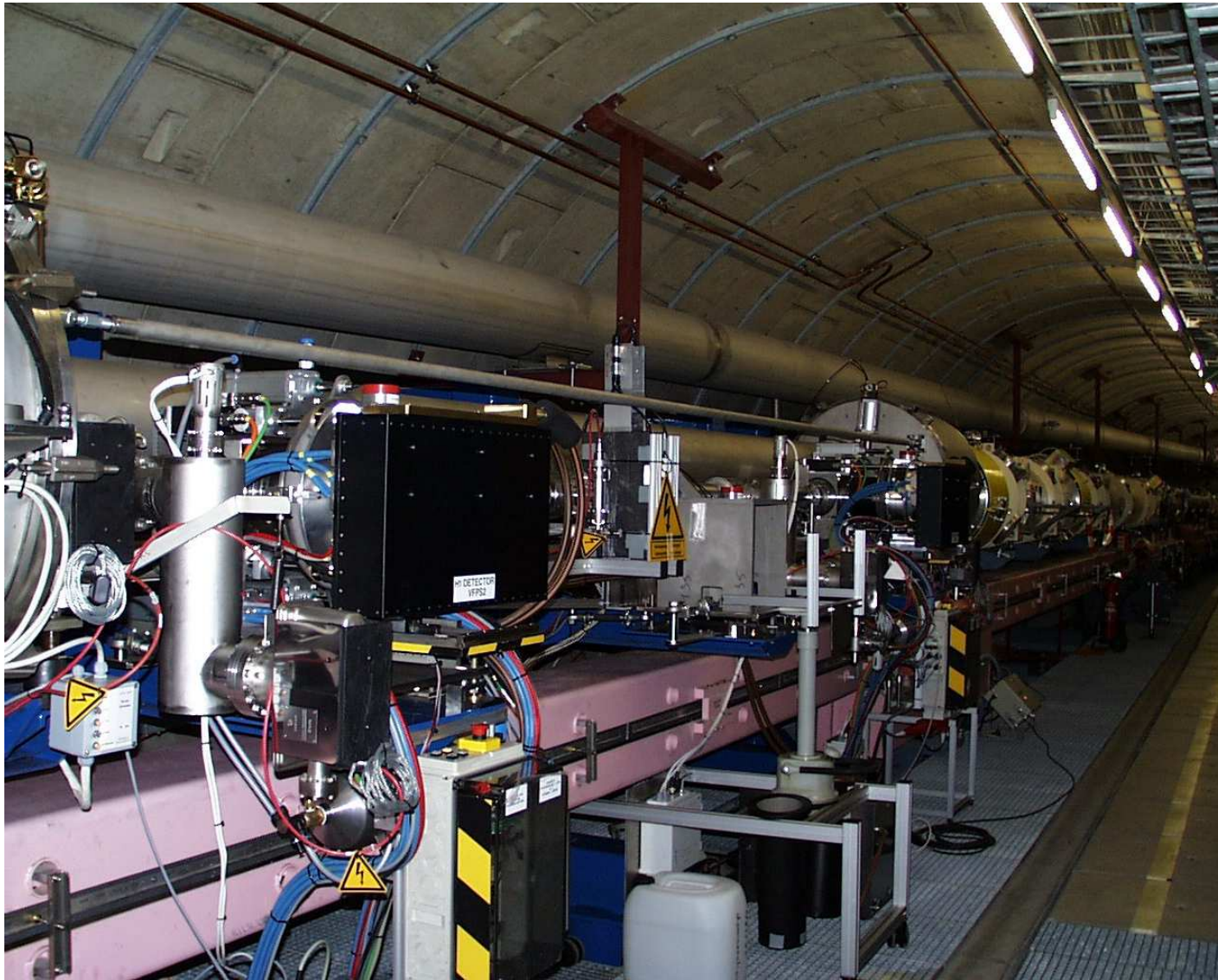

VFPS Tests Data

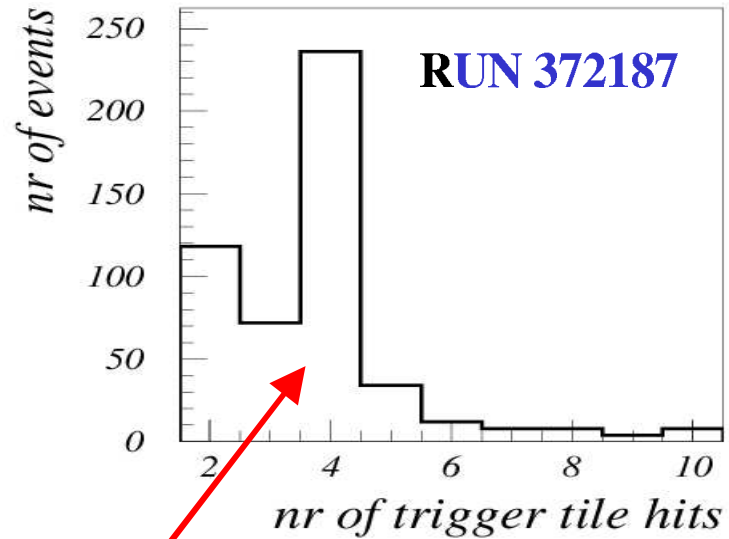
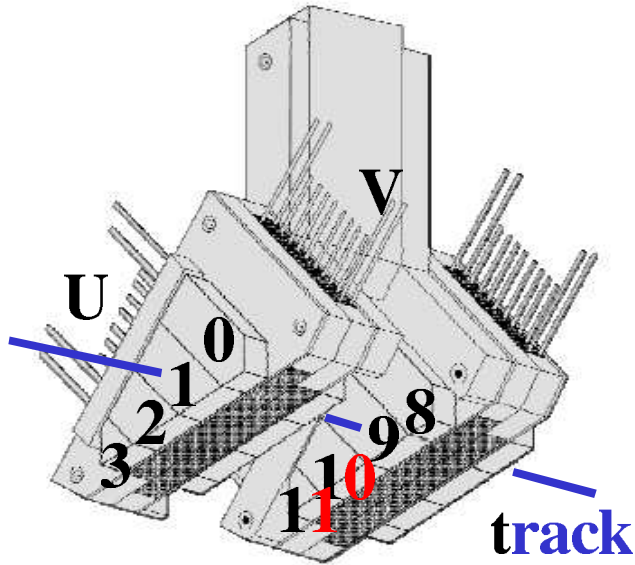

Coincidence of 4 triggered planes

Reconstructed slope is close to zero

→ Tracks are nearly parallel to beam line

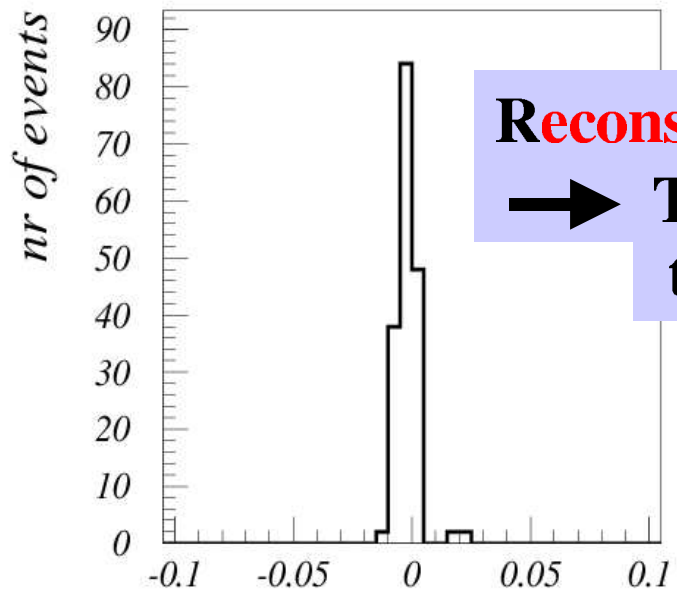

X-slope in beam line frame (rad.)

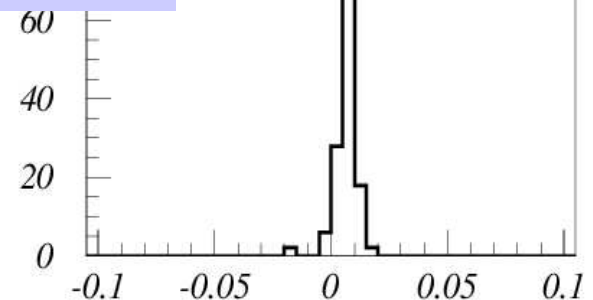

Y-slope in beam line frame (rad.)

Expected Results: Inclusive Diffraction

Predicted $F_2^{D(3)}$ for 350 pb^{-1} (50% VFPS operation efficiency over 3 years)

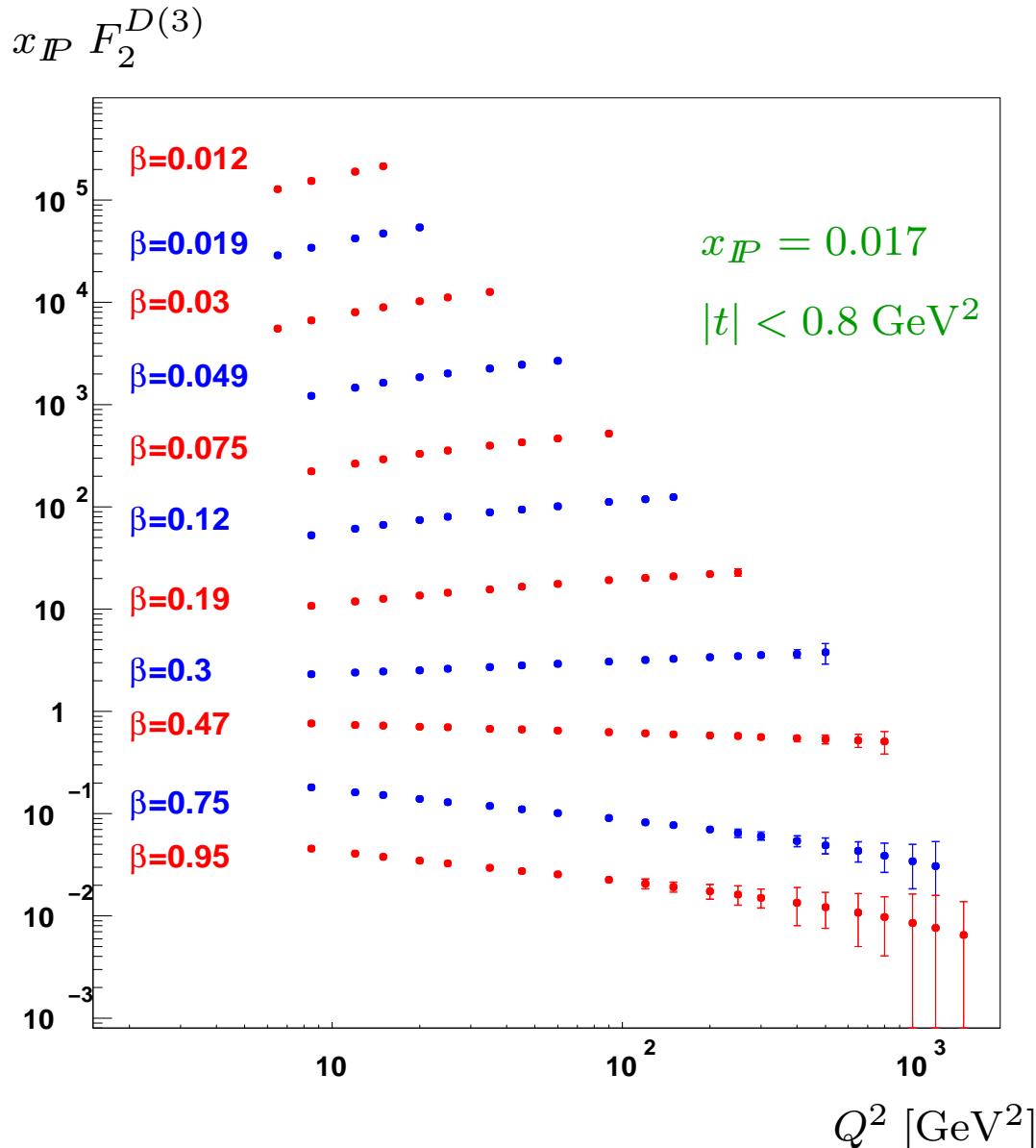

10^6 Events for $Q^2 > 5 \text{ GeV}^2$

→ Study t dependence

$$\longrightarrow F_2^{D(4)}(Q^2, \beta, x_{\mathbb{P}}, t)$$

Uncorrelated systematic errors can reach 2-3 % (similar to F_2 precision)

→ Extract diffractive pdf's at fixed $x_{\mathbb{P}}$ and t and predict final states at same $x_{\mathbb{P}}$ and t to test factorization theorem

Expected Results: F_L^D Measurements

$$\sigma_r^{D(4)} = F_2^{D(4)} - \frac{y^2}{2(1-y+y^2/2)} F_L^{D(4)} \quad y = Q^2/s_{ep} x$$

ϕ Asymmetry

pQCD calculable higher twist F_L^D expected dominant at high β

→ Measure ϕ asymmetries as function of β (and Q^2)

VFPS : 15 bins in ϕ with 10000 events each for $|t| > 0.2 \text{ GeV}^2$

Reduced proton beam energy

40 % precision on σ_L^D / σ_T^D expected with 50 pb^{-1} data
at $E_p = 500 \text{ GeV}$

Expected Results: Final States

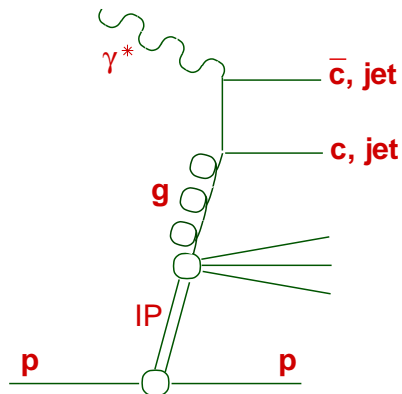

Di-jets

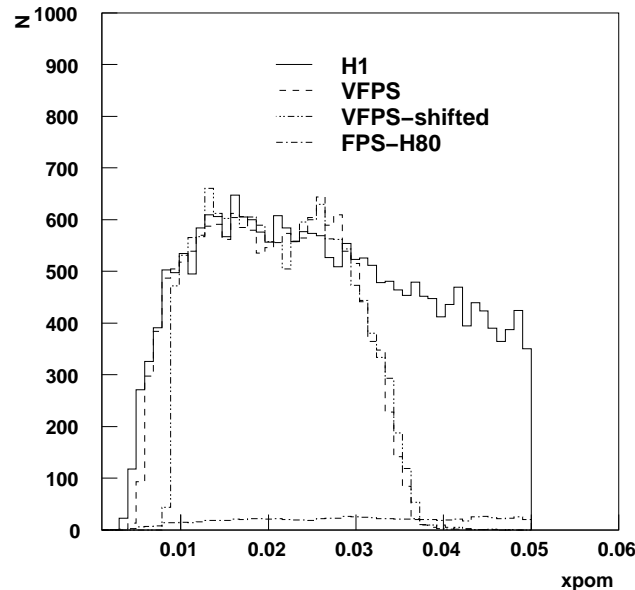

Open Charm

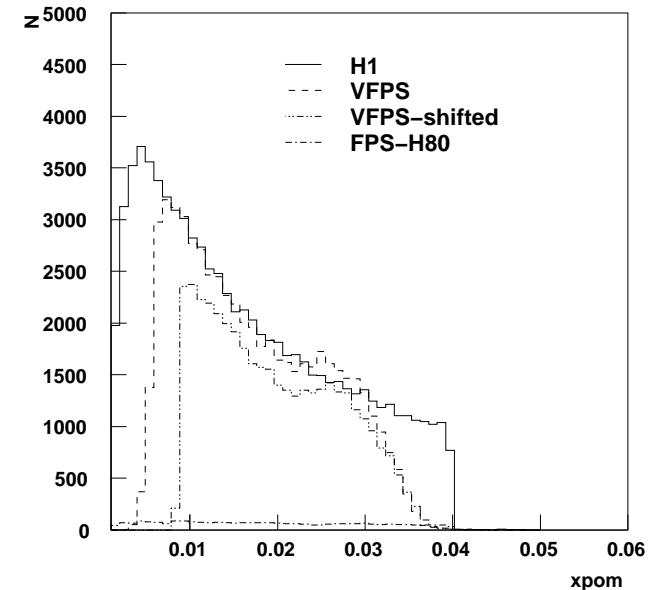

Di-jets electroproduction

- 96/97 analysis: 2500 events
- VFPS: expect 22900 events

Open Charm (D^*)

- 96/97 analysis: 46 ± 10 events
- VFPS: expect 380 events

- More differential studies (in particular for D^*)
- Direct (vs) resolved photon contributions
- Test of diffractive factorization theorem

Expected Results: Exclusive Channels

Deeply Virtual Compton Scattering

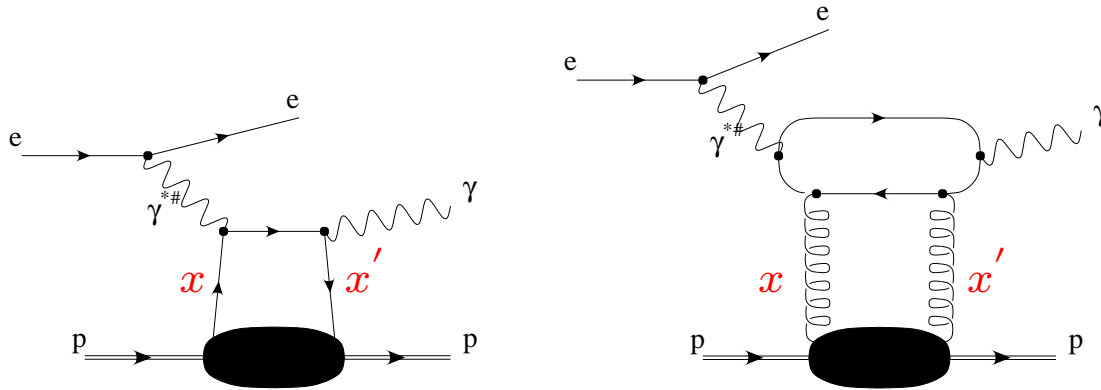

Sensitive to GPD (extension of pdf for $x \neq x'$) via interf. with Bethe Heitler

→ Measure charge ($\propto \text{Re } A_{DVCS}$)
and helicity ($\propto \text{Im } A_{DVCS}$) asymmetries

- DVCS + BH in H1 acceptance
- H1 triggered DVCS + BH
- VFPS : DVCS + BH
- Pure BH contribution

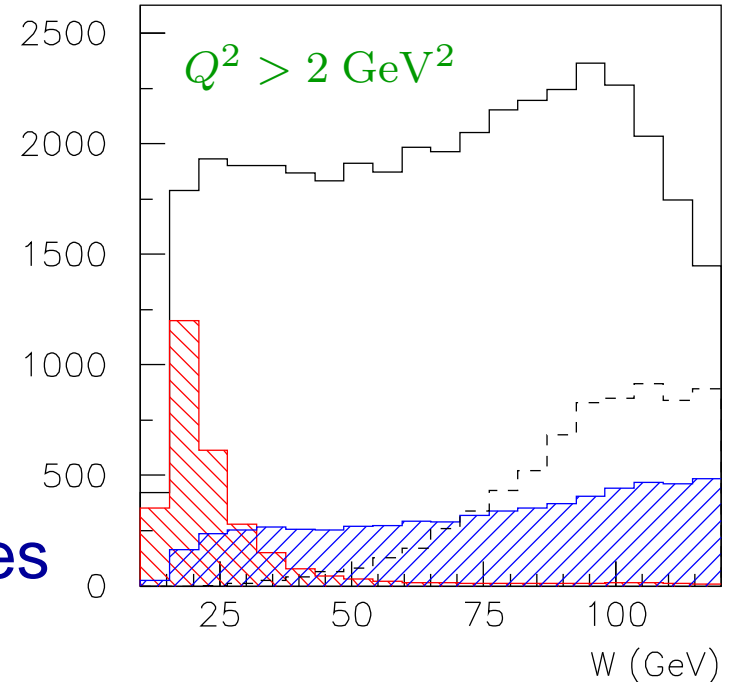

Vector Meson Production

$$e + p \longrightarrow e + p + VM \quad ; \quad VM = \rho, J/\psi, \dots$$

Clean elastic channel selection **BUT** only low W accessible

CONCLUSION

- H1 has installed a new proton spectrometer (VFPS) with a large acceptance for low $x_{\mathbb{P}}$ and $0 < |t| < 0.5 \text{ GeV}^2$
 - High precision studies of diffraction :
 - F_2^D , t Dependence, F_L^D and ϕ Asymmetries
 - Final states (di-jets, open charm) + Test of factorization
 - DVCS (access to GPD) and Vector Meson
- First test data, including tracks, have been recorded and the detector commissioning is in progress
 - Physics data have to be expected soon